

RADIO'S LIVEST MAGAZINE

Special
**SHORT
WAVE**
Number

OVER 175 ILLUSTRATIONS

Radio-Craft

HUGO GERNSBACH EDITOR

January

25 Cents

in United States
and Canada



2-WAY
POLICE
RADIO

See Page 394

Build the **RADIO-CRAFT 1937 Television Receiver**—The Gridless Tube!
Service Men's Condenser Analyzer—Tuning-in DX—New S.-W. Converter

OVER 50,000 RADIO MEN READ RADIO-CRAFT MONTHLY

NOW... RADIO SERVICING IS MORE PROFITABLE ... EASIER



MODEL
740
DEALER PRICE
Only \$18.60

VOLT-OHM MILLIAMMETER

WITH
**RANGER
EXAMINER**

AVAILABLE NOW IN SINGLE TESTERS ALSO COMBINATIONS TO
SUIT YOUR NEEDS.

EYE APPEAL..PRECISION ACCURACY

YOU AND YOUR CUSTOMERS WILL APPRECIATE THE UTMOST IN PROFESSIONAL APPEARANCE

Yes, Ranger-Examiner Equipment definitely means that Radio Service work can be done more profitably and easier. More profitably because considerably less money is required for precision equipment, and easier because Ranger-Examiner is a completely new line designed from scratch with all the latest improvements for quick and accurate service. Less weight, too, to carry around in sturdy all-metal cases. Ranger-Examiner testers are manufactured by the oldest company in the service equipment field whose contacts make them fully acquainted with the needs of the radio serviceman.

Model 740 Volt-Ohm-Milliammeter has a Triplett 3" square Precision Instrument. Scale readings: 10-50-250-500-1000 A.C. and D.C. Volts at 1000 Ohms per Volt (D.C. Accuracy 2%; A.C. 5%) 1-10-50-250 D.C.M.A.; 0-300 low ohms; high ohms to 250,000 at 1.5 volts. Rheostat adjustment for 13½ volts for ohm readings to 2.5 megohms. Batteries may be added permitting higher resistance readings in 250,000 ohms steps. Low Ohms to ½ Ohm—with 25 ohms in center of scale. Backup circuit. Current draw is only 1 M.A.

Compare First . . . Then Buy Ranger-Examiner

Be sure to send Coupon for your FREE copy "101 Radio Troubles and Their Cures."

Get this
FREE
BOOKLET
LISTING 101 MOST
FREQUENT RADIO
TROUBLES

★
**HOW TO DETECT
HOW TO CURE**

★
**NOTHING LIKE IT BEFORE
GREATLY SIMPLIFIES
EVERYDAY SERVICE**

**SEND
COUPON
NOW . . .**



READRITE METER WORKS
116 College Dr., Bluffton, Ohio

Without obligation please send me your free Booklet, "101 Radio Troubles and Their Cures," and complete Ranger-Examiner Catalog.

Name

St. Address

City

State

OPPORTUNITIES *are many* for the Radio Trained Man



Don't be an untrained man. Let me show you how to get your start in Radio—a fast growing, live money-making industry.

Prepare for jobs as Assembler, Inspector and Tester—Radio Sales or Service and Installation Work—Broadcasting Station Operator—Wireless Operator on a Ship or Airplane, Talking Picture or Sound Work—**HUNDREDS OF OPPORTUNITIES** for a real future in Radio!

12 Weeks of Shop Training

We don't teach by book study. We train you on a great outlay of Radio, Television and Sound equipment—on scores of modern Radio Receivers, actual Broadcasting equipment, Television apparatus, Talking Picture and Sound Reproduction equipment, Code and Telegraph equipment, etc. You don't need advanced education or previous experience. We give you—**RIGHT HERE IN THE COYNE SHOPS**—the actual practice and experience you'll need for your start in this great field. And because we cut out all useless theory and only give that which is necessary you get a practical training in 12 weeks. Mail coupon for all facts about my school and training methods.

TELEVISION *and* TALKING PICTURES

Television is sure to come as a commercial industry. Whether this year or later, it will offer opportunities to the man who is trained in Radio. Here at Coyne you learn Television principles, and work on actual Television equipment. Talking Picture and Public Address Systems offer opportunities to the Trained Radio Man. Here is a great new Radio field which is rapidly expanding. Prepare **NOW** for these wonderful opportunities! Learn Radio Sound Work at COYNE on actual Talking Picture and Sound Reproduction equipment. Not a home study course.

PAY TUITION ON EASY PAYMENT PLAN

Mail the Coupon below and I'll tell you about my payment plan which has enabled hundreds of others to get Coyne training with very little money. On this plan you can get your training first, then take 18 months to complete your small monthly tuition payments starting 5 months after you begin training. Not a home study course.

Mail the coupon for all details of this "Pay Tuition after Graduation Plan."

ELECTRIC REFRIGERATION—AIR CONDITIONING—DIESEL ENGINES

To make your training more valuable, I include—at no extra cost—valuable instruction in Electric Refrigeration, Air Conditioning and Diesel Engines, taught you by personal instruction and actual work on real equipment.

PRACTICAL WORK At COYNE in Chicago

ACTUAL, PRACTICAL WORK. You build and service radio sets. You get training on real Broadcasting equipment. You construct Television Receiving Sets and actually transmit your own Television images over our Television equipment. You work on real

H. C. LEWIS, Pres. RADIO DIVISION Founded 1899

Coyne Electrical School
500 S. Paulina St., Dept. 17-8H, Chicago, Ill.

Talking Picture and Sound equipment. You learn Wireless Operating on Actual Code Practice apparatus. We don't waste time on useless theory. We give you the **practical training** you'll need for your start in Radio—in 12 short weeks. If you desire code, this requires additional time for which there is no extra charge.

MANY EARN WHILE LEARNING



If you need part-time work to help pay living expenses while at school, tell us your problems and we may be able to help you as we have hundreds of other students. Then, after you graduate, lifetime employment service will be available to you. Every Coyne graduate also receives a Life Membership, with free technical and business service and privilege of review at any time without additional tuition charge.

Mail Coupon Today for All the Facts

H. C. LEWIS, President
Radio Division, Coyne Electrical School
500 S. Paulina St., Dept. 17-8H, Chicago, Ill.

Dear Mr. Lewis:—Send me your Big Free Radio Book, and all details of your tuition offer, including valuable instruction in Electric Refrigeration, Air Conditioning and Diesel Training and your "Pay Tuition After Graduation" offer.

Name.....
Address.....
City..... State.....

Please Say That You Saw It in RADIO-CRAFT



HUGO GERNSBACK, Editor-in-Chief
 C. W. PALMER Technical Editor
 R. D. WASHBURNE, Managing Editor
 C. P. MASON Associate Editor

CONTENTS - JAN., 1937, ISSUE
 Volume VIII Number 7

Editorial: Short-Wave Applications..Hugo Gernsback 389
 The Radio Month in Review..... 390
 Ultra-Ultra-Microwave "Radio" of the Future
W. E. Shrage 392
 New Developments in Short-Wave Radio..... 394
 New High-Intensity Cathode-Ray Tube Effects Tele-
 vision Theatre 394
 New Tubes for the New Year.....J. H. Green 395
 Gridless vs. Grid Tubes—Part II....Henri F. Dalpayrat 396
 How to Make the RADIO-CRAFT 1937 Television
 Receiver—Part I 398
 A Simplified Converter for Short-Wave Beginners
 —Part IRaymond P. Adams 400
 Sun-Spots and Short-Wave Radio Fade-Outs
R. F. Richardson 402
 WPA Police-Radio "Noise Detectives"
A. W. von Struve 402
 How to Get "Long Distance" on Your All-Wave Set
M. Harvey Gernsback 403
 Modern Short-Wave Diathermy—Part I
Leon C. Bunkin 404
 Looking Ahead in the Radio Field—Part III
R. D. Washburne 405
 Build This 12- to 500-Meter "Bandswitch 5"
Guy Stokely 406
 Uncle Sam's War Against "Bootleg" Transmitters
John B. Reynolds 406
 Making a Radio-Controlled Model "Saratoga"—Part
 II.....George C. Fitzgerrell 407
 New "Current-Saver" Circuit for 18-Tube All-Wave
 SetCharles Sloan 408

ORSMA Members' Forum..... 408
 Experiments with a "Hi-Fi" Amplifier—Part II
Arthur H. Lynch 409
 Build This Beat Oscillator for DX Reception and Code
C. P. Mason 410
 Basic Oscillator Circuits You Should Know
Alfred A. Ghirardi 410
 Useful Radio Circuits..... 411
 A New Transformer Development.....J. B. Carter 412
 An Easily-Built Condenser Analyzer for the Servicing
 Beginner.....Alfred W. Bulkley 413
 New Developments in Cathode-Ray Equipment—Part
 II.....Garland W. Archer 413
 The Latest Radio Equipment..... 414

RADIO SERVICE DATA SHEETS:

Nos. 186 and 187—Philco Model '37-116 (Shadow-
 meter) and 122 (Dial Tuning)..... 416
 No. 188—RCA-Victor Models 9T and 9K2, 5-Band
 9-Tube Superheterodyne 420
 Operating Notes 418
 Newest Car-Radio Servicing Panel..... 418
 Technicians' Data Service..... 422

SPECIAL BROADCAST NUMBER

Watch for the next issue of RADIO-CRAFT in which every radio-man, no matter what his specialty may be, will find interesting articles.

Broadcasting in one form or another—network, short-wave, television, high-fidelity—is moving toward new unheard of levels of perfection. Only the informed and up-to-date radio man can hope to progress with this fast-moving industry. You owe it to yourself to read each issue of RADIO-CRAFT so that you too can keep abreast of the times.

Reserve your copy now at your regular newsstand.

Published by Radcraft Publications, Inc. Publication office: 29 Worthington Street, Springfield, Mass. Editorial and Advertising Offices: 99 Hudson Street, New York City. Chicago Advertising Office: L. F. McClure, 919 North Michigan Avenue, Chicago, Ill. Western Advertising Office: Loyd B. Chappell, 511 So. Alexandria St., Los Angeles, Calif.

Foreign Agents:
 London—Gorrings' American News Agency, 9A Green St., Leicester Square, W. C. 2, England.
 Paris—Messageries Dawson, 4 Rue Faubourg, Poissonniere, France.
 Melbourne—McGill's Agency, 179 Elizabeth St., Australia.
 Dunedin—James Johnston, Ltd., New Zealand.

RADIO-CRAFT is published monthly, on the first of the month preceding that of date; subscription price is \$2.50 per year in U. S. and Canada. (In foreign countries, \$3.00 a year to cover additional postage.) Entered at the post office at Springfield as second-class matter under the act of March 3, 1879.

Text and illustrations of this magazine are copyright and must not be reproduced without permission of the copyright owners.

Copyright 1936. Radcraft Publications, Inc.



**J. E. SMITH, President
NATIONAL RADIO INSTITUTE**

The man who has directed the home study training of more men for the Radio industry than any other man in America.

I will send you a Lesson Free to show how I train you at home in spare time for Good Jobs in Radio



Broadcasting Stations

Employ managers, engineers, operators, installation and maintenance men for fascinating jobs and pay up to \$5,000 a year.



Set Servicing

Spare time set servicing pays many \$5, \$10, \$15 a week extra while learning. Full time servicing pays as much as \$30, \$50, \$75 a week.

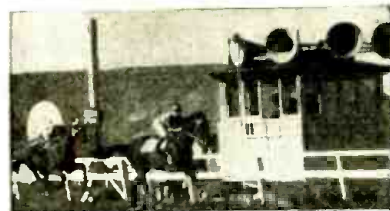

Loud Speaker Systems

Building, installing, servicing and operating public address systems is another growing field for men well trained in Radio.

Lesson on Radio Servicing Tips FREE

I'll prove that my Training gives practical, money-making information, that it is easy to understand—that it is just what you need to master Radio. My sample lesson text, "Radio Receiver Troubles—Their Cause and Remedy," covers a long list of Radio receiver troubles in A.C., D.C., battery, universal, auto, T. R. F., super-heterodyne, all-wave, and other types of sets. And a cross reference system gives you the probable cause and a quick way to locate and remedy these set troubles. A special section is devoted to receiver check-up, alignment, balancing, neutralizing and testing. Get this lesson Free. No obligation.

**MAIL
COUPON
NOW**



The Tested Way to BETTER PAY

Do you want to make more money? I'm so sure that I can train you at home in your spare time for a good Radio job that I'll send you a lesson absolutely FREE. Examine it, read it, see for yourself how practical it is to learn Radio at home, how easy it is to understand—even if you've never had technical experience or training.

Many Radio Experts Make \$30, \$50, \$75 a Week

Radio broadcasting stations employ engineers, operators, station managers and pay up to \$5,000 a year. Spare time Radio set servicing pays as much as \$200 to \$500 a year—full time jobs with Radio jobbers, manufacturers and dealers pay as much as \$30, \$50, \$75 a week. Many Radio Experts own and operate their own full time or part time Radio sales and service businesses. Radio manufacturers and jobbers employ testers, inspectors, foremen, engineers, servicemen, paying up to \$6,000 a year. Automobile, police, aviation, commercial Radio, and loud speaker systems are never fields offering good opportunities now and for the future. Television promises to open many good jobs soon. Men I have trained are holding good jobs in these branches of Radio. Read their statements in my 64-Page Book. Mail the coupon.

There's a Real Future in Radio for Well Trained Men

Radio already gives jobs to more than 300,000 people. In 1935 over \$300,000,000 worth of sets, tubes and parts were sold—an increase of 20% over 1934! Over 1,100,000 auto Radios were sold in 1935, 25% more than in 1934! 22,000,000 homes are today equipped with Radio, and every year millions of these sets go out of date and are replaced with newer models. Millions more need servicing, new tubes, repairs, etc. Broadcasting stations pay their employees (exclusive of artists) more than \$23,000,000 a year! And Radio is a new industry, still growing fast! A few hundred \$30, \$50, \$75-a-week jobs have grown to thousands in less than 20 years.

Many Make \$5, \$10, \$15 a Week Extra in Spare Time While Learning

Practically every neighborhood needs a good spare time serviceman. The day you enroll I start sending you Extra Money Job Sheets. They show you how to do Radio repair jobs that you can cash in on quickly. Throughout your training I send you plans and ideas that have made good spare time money—from \$200 to \$500 a year—for hundreds of fellows. My training is famous as "The Course that pays for itself."

I Send You Special Radio Equipment to Give You Practical Experience

My Course is not all book training. I send you special Radio equipment and show you how to conduct experiments and build circuits which illustrate important principles used in modern Radio receivers, broadcast stations and loud speaker installations. I show you how to build testing apparatus for use in spare time service work from this equipment. You work out with your hands many of the things you read in the lesson books. My Free Book tells you about this 50-50 method of training—how it makes learning at home interesting, fascinating, practical. Mail Coupon.

Save Money—Learn at Home Money Back Agreement Protects You

I am so sure that I can train you at home successfully that I agree in writing to refund every penny you pay me if you are not satisfied with my Lessons and Instruction Service when you finish my Course. I'll send you a copy of this agreement.

Get My Lesson and 64-Page Book Free Mail Coupon

In addition to my Sample Lesson, I will send you my 64-Page Book, "Rich Rewards in Radio." Both are free to any fellow over 16 years old. My book describes Radio's spare time and full time opportunities and those coming in Television; describes my Training in Radio and Television; shows you actual letters from men I have trained, telling what they are doing and earning. Find out what Radio offers YOU! MAIL THE COUPON in an envelope, or paste it on a penny post card—NOW!

**J. E. Smith, President
National Radio Institute,
Dept. 7AX, Washington, D. C.**

HERE'S PROOF



\$10 Week in Spare Time

"My work has consisted of Radio set servicing, with some Public Address Systems work—all in my spare time. My earnings in Radio amount to about \$10 a week."—WILLIAM MEYER, 705 Ridge Road, Hobart, Ind.



Earnings Tripled By N.R.I. Training

"I have been doing nicely, thanks to N. R. I. Training. My present earnings are about three times what they were before I took the Course. I consider N. R. I. Training the finest in the world."—BERNARD COSTA, 201 Kent St., Brooklyn, N. Y.



THIS FREE BOOK HAS HELPED HUNDREDS OF MEN MAKE MORE MONEY

Good for FREE SAMPLE LESSON and BOOK on RADIO'S OPPORTUNITIES

J. E. SMITH, President
National Radio Institute, Dept. 7AX
Washington, D. C.

Dear Mr. Smith: Without obligation send me free the Sample Lesson and your 64-Page Book, "Rich Rewards in Radio," telling about spare time and full time Radio opportunities, and how I can train for them at home in spare time. (Please write plainly)

Name Age

Address

City State 14x1

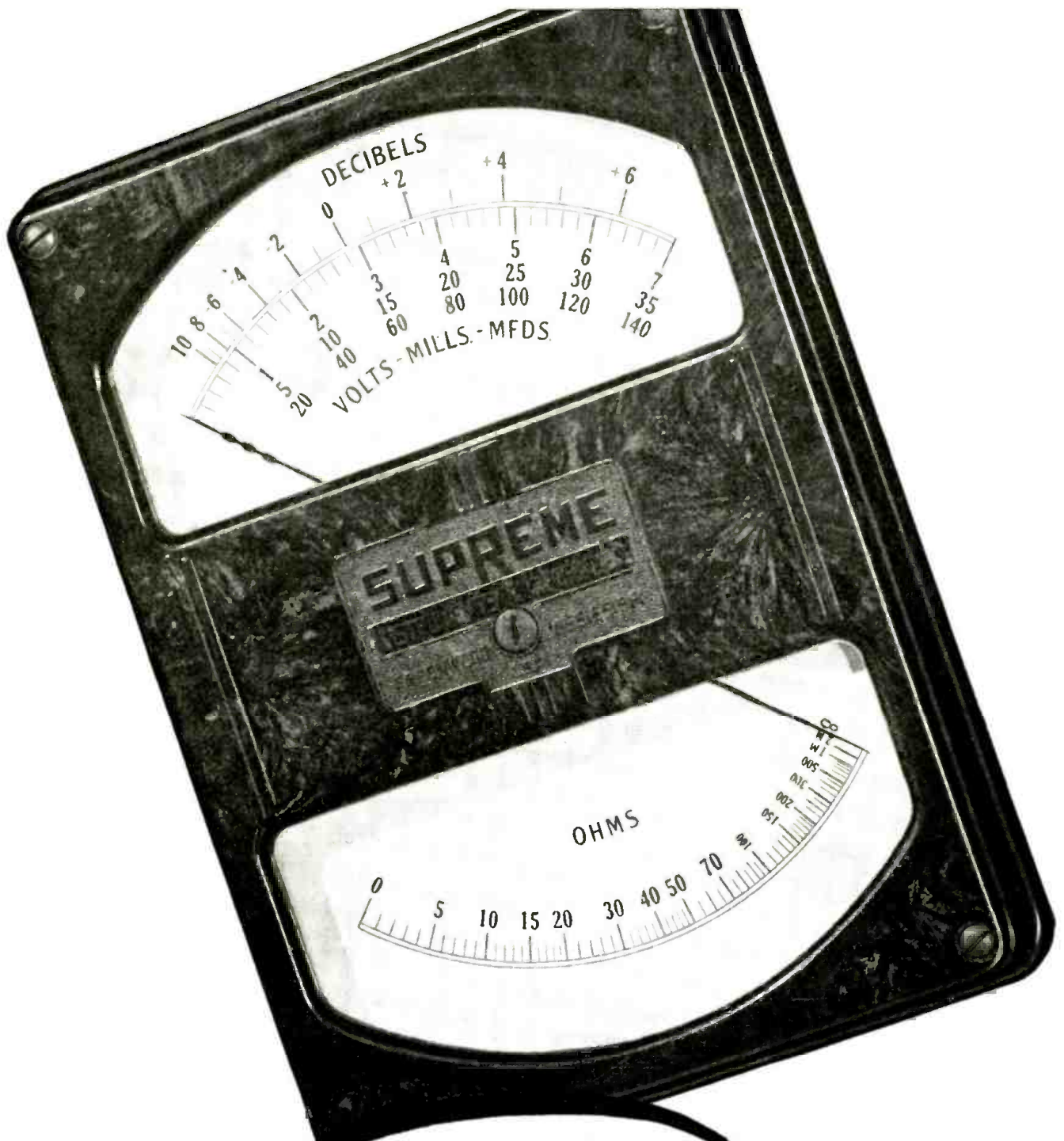

Westinghouse

BUILDS THE SENSATIONAL NEW SUPREME QUADRIMETER!
 "To have the best possible measuring instrument for use in the great Supreme Analyzer Models for 1937, the Supreme Instruments Corporation went to Westinghouse for the new Supreme Quadrimeter, with the only Dual Pointer mechanism.

"Proper heat treatment and aging of the forged permanent magnets, sturdy coil construction and highly polished hard-steel pivots, and genuine Sapphire jewel bearings are used. These features assure characteristic an accurate movement that cannot be deranged under the most severe service."

Westinghouse Instruments Corporation

Please Say That You Saw It in RADIO-CRAFT

Only SUPREME

COULD BUILD THE SENSATIONAL NEW 1937 SUPREME INSTRUMENTS

Years of experience in the design of radio testing equipment . . . plus a thorough understanding of what servicemen want . . . plus the realization that portable testing instruments must be not only versatile and practical but also impressive enough to make it possible for a serviceman to demand a profit on every job. All those elements were essential to the design of the 17 new SUPREME instruments.

**\$750 DOWN
\$661 PER MONTH
FOR 10 MONTHS**



MODEL 500 combines 10 essential servicing instruments: Tube quality checker. Tube leakage and short tester. Electrolytic condenser analyzer. Paper and mica condenser checker. Multi-range D.C. volt-meter. Multi-range A.C. voltmeter. Multi-range decibel meter. Multi-range milliammeter. Multi-range output meter. Cash Price \$66.95

**SUPREME INSTRUMENTS CORPORATION
GREENWOOD, MISSISSIPPI**

WHERE SHOULD THE RADIO SERVICE MAN LOCATE HIS PLACE OF BUSINESS

"This interesting booklet is the result of a nation-wide survey and presented for your benefit. Write me today and I will mail you a copy free of charge."



Your Parts Gobbler

Please Say That You Saw It in RADIO-CRAFT

9 x 12
INCHES

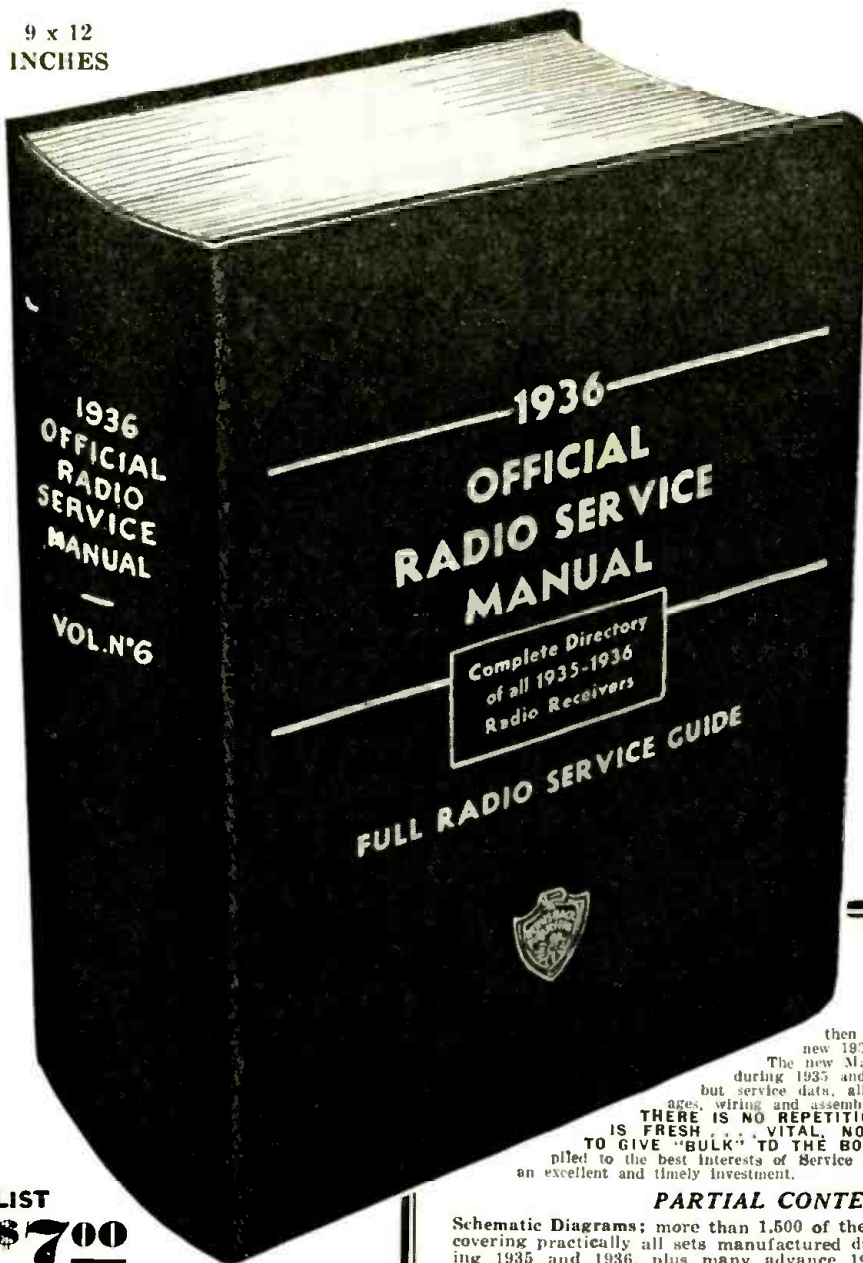

**SEND FOR YOUR
1936
OFFICIAL RADIO
SERVICE MANUAL
TODAY—**

**IT'S READY FOR
IMMEDIATE MAILING!**

Bigger and Better than Ever!.....

more diagrams, more data, more pages, more essential service material and considerably greater value for your money. If the sale of previous Gernsback Manuals is any indication then many thousands more Service Men will be using this new 1936 Manual than any of the previous volumes. The new Manual incorporates all available diagrams of sets manufactured during 1935 and 1936, plus many advance 1937 models. Not only diagrams, but service data, alignment procedure, intermediate frequency peaks, socket voltages, wiring and assembly diagrams, etc., etc., are included. **THERE IS NO REPETITION IN THIS MANUAL! EVERY BIT OF INFORMATION IS FRESH... VITAL, NO REHASH... AND NO USELESS MATERIAL JUST TO GIVE "BULK" TO THE BOOK.** The entire contents has been carefully edited and compiled to the best interests of Service Men. The 1936 OFFICIAL RADIO SERVICE MANUAL is an excellent and timely investment.

PARTIAL CONTENTS OF 1936 MANUAL

Schematic Diagrams; more than 1,500 of them, covering practically all sets manufactured during 1935 and 1936, plus many advance 1937 models. Many of them have the operating voltages of the various tube elements printed directly on them.

Wiring Diagrams; wherever they have been obtainable, the wiring diagrams of the more complex receivers, such as the all-wave and high-fidelity sets, have been included.

Miscellaneous Diagrams; these include speaker connections, optional phonograph connections, power transformer connections, R. F. and I. F. coil connections, complete phonograph motor connections on combination receivers, etc., etc. Wherever these diagrams were available they have been included in the 1936 Manual.

Intermediate Frequency Peaks; all set models (with few exceptions) have their respective intermediate frequency peaks marked either directly on their schematic diagrams or in their notes on alignment procedure.

Alignment Procedure; even if space permitted, it would not have been advisable to print the alignment procedure on all the simpler sets for one would have been a repetition of the other. On the more complex receivers, however, the all-wave and high-fidelity sets, complete alignment procedures, step-by-step, have been included.

Service Data; wherever the information was made available to us, such data as typical faults in a given receiver, their symptoms and remedies, was included in the 1936 Manual. **Assembly Diagrams;** on combination models, i. e., sets combined with phonographs (either the manual or automatic types), complete assembly diagrams are given. These diagrams show the relationship of the separate units to each other and the way they are inter-connected. **Operating Voltages;** the operating voltages given in this Manual (for more than 80% of the sets listed) are the normal voltages; any deviation from these values indicates trouble in the associated circuits.

Trade Name Index; in the back of the book, is a complete index of trade names and their respective manufacturers.

Complete Tube Chart; in the back of the Manual will be found the latest, and most complete tube chart of all type tubes ever manufactured for receivers.

Large Cumulative Index; includes all sets printed in the 1931, 1932, 1933, 1934, 1935 volumes as well as the present 1936 Manual. The sets in this volume have been listed in the index in an entirely new and more convenient manner so that the busy Service Man need no longer thumb through an entire manufacturer's section in order to find some particular piece of information. He need but consult the index.

If your jobber or mail order house cannot supply you, order any of the OFFICIAL RADIO SERVICE MANUALS or the OFFICIAL RADIO SERVICE HANDBOOK from the publishers. Send your remittance in form of check or money order—or, if you send cash or unused U. S. Postage Stamps, be sure to register your letter. ALL ORDERS ARE FILLED PROMPTLY. BOOKS ARE SENT TO YOU POSTAGE PREPAID.

Address Dept. RC-137.

RADCRAFT PUBLICATIONS, INC., 99 Hudson St., New York. N.Y.

LIST
\$7.00

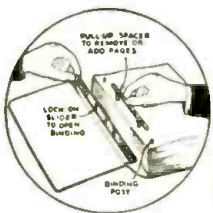

New Practical Binder

Note, at the left, the details of the new binder used on this manual. It not only securely locks the 1200 pages into the stiff leatheroid covers, but facilitates removal and replacement of individual pages.

**1,200
PAGES
OVER
2,500
ILLUSTRATIONS**

*Looseleaf Binder
Hard Covers*

GERNSBACK RADIO SERVICE MANUALS ARE AVAILABLE FROM JOBBERS AND MAIL ORDER HOUSES

Please Say That You Saw It in RADIO-CRAFT



"Takes the Resistance out of Radio"

Editorial Offices: 99 Hudson St., New York, N. Y.

HUGO GERNSBACK, Editor

Vol. VIII, No. 7, Jan. 1937

SHORT-WAVE APPLICATIONS

An Editorial by HUGO GERNSBACK

SHORT WAVES have been with us only a few short years; yet, what most amazes even the short-wave expert is the tremendous number of new uses to which short waves are being put, day in and day out.

To do the subject full justice, by just enumerating the uses, would fill several of these pages of closely-printed type. But, as yet, we have only scratched the surface, and the most important uses of short waves are still to come. In the meanwhile, not a month passes by when we do not hear of new and surprising uses of short waves. Indeed, even the short-wave expert is hard put to keep track of all of them; for, as soon as he has completely investigated one new application, a newer one is already in full bloom.

Thus, for instance, the radio typewriter operating by short waves, which was mostly theory for a number of years, is now an accomplished fact. Most of the technical difficulties have been eliminated; and it is now possible for you to sit down at your typewriter, somewhere in the wilds, and type out a message which even through thunderstorms and static will come through practically faultless and neatly typed on a sheet of paper 300 miles away—or a thousand miles—on the receiving typewriter.

Short-wave "paging" is another surprising new development. Application has been made to the Federal Communications Commission to set aside a special wave-band, in the 30-50 megacycle region, for physicians. Nowadays, patients are handicapped in not being able to reach their physicians, particularly when the latter are making calls. The new radio paging system is a method of signalling only those doctors who are wanted. No message or word of instruction comes to the doctor while en route in his car; he receives in his own car, a pre-set signal, which requires him to hurry to the nearest telephone and ask the radio-paging service for his message. If the doctor should be calling on a patient, the radio receiving set responds by setting off a buzzer, or lighting a pilot lamp, only in his car; the pilot lamp or buzzer remains in operation until released by the doctor. This method will save the life and health of many a patient, particularly when doctors are required promptly.

Weather forecasting, through direct use of short waves, is becoming an accurate science. Not so long ago, it was found at the Blue Hill observatory, at Milton, Massachusetts, that ultra-high-frequency radio signals underwent variations in intensity which almost matched the changes in temperature, between the surface and a height of some 6,900 feet. These variations are now used for weather forecasting, and rapid progress is being made in this direction.

The long-heralded facsimile and picture transmission by short waves is now an accomplished fact. Photographs, sketches, reproductions of checks with signatures, are now actually flashing across the country and across the oceans every day. Transmission, frequently, is of exactly the same high quality as though it had gone over a wire line. There are a number of inter-city facsimile stations operating between the different cities of the United States now, and the system may be considered highly successful.

The war uses of short waves, in the meanwhile, are taking on greater and greater proportions. All of the different governments have experimented with radio-controlled machines and, while much secrecy naturally surrounds these experiments, it has become known that a number of military and naval organizations are actually equipping various types of war machines with short waves as standard equip-

ment. Thus, for instance, we have the radio-controlled torpedo. By means of short waves, it is now possible to direct and steer a torpedo accurately from a distant observation point, and explode it at the proper moment. During the World War, it was possible for a vessel to escape destruction by zigzagging away from a torpedo's course. This method will be of little use in the next war; because the radio-controlled torpedo will find its mark, no matter how desperately the attacked vessel may try to get out of the oncoming torpedo's way. Of course, governments, being aware of this emergency, are already experimenting also with "counter torpedoes"; whereby the attacked vessel will send out a similar torpedo which will try to head off the oncoming torpedo and explode it before it can reach its mark.

There are, of course, many other uses of short waves for war purposes, many of which have been described in *Radio-Craft* magazine. The radio-controlled tank, for instance, is another development whereby such a tank can be maneuvered without any human being on board. Instead, the tank will contain explosives; so that it can be blown up at strategic points without uselessly sacrificing human lives.

The same idea has already been made use of in airplanes, particularly those of the bombing variety. Such short-wave robot airplanes have been used experimentally for over two decades now, and it might be said that they have reached an amazing degree of perfection.

For example, despite any enemy interference, with short waves it now becomes possible to send an airplane aloft and make it go through a variety of motions—drop bombs at specified points, and even operate machine guns on board—all without a human being within the plane. Such robot planes can now be operated from other, following planes if necessary. The robot plane itself can be destroyed by an internal bomb when necessary, so that it will not fall into the enemy's hands; yet when it explodes a maximum amount of damage is done!

In the more peaceful arts, short waves in medicine have made rapid strides and an entirely new industry has sprung up in short-wave therapy; there are now engaged in it dozens of manufacturers who turn out short-wave equipment for physicians. It will not be long now before every physician, or at least the majority of the physicians in this country, will own their own short-wave therapeutic machines. There have been many surprising cures, especially of boils, carbuncles, and infectious diseases which yield rapidly to the effects of short waves. There have been a number of new improvements in the short-wave therapy field, and many physicians who place great hope in this instrumentality for the future. It is to be noted that this particular type of medicine has been in use only for about 5 years, and no one can tell where it will lead to in the next 10 or 15 years.

Even building contractors now have use for short waves, because it has been found that plaster ceilings and plaster walls can be dried much more efficiently with short waves than with other heating means! Heretofore, when an apartment house was built, it was found necessary either to let the walls and ceilings dry slowly, which was the best method, or to turn on the steam heat—this latter method usually resulting in cracks, due to the too rapid drying. By means of short waves, the drying proceeds from *within* the surface to the outside, exactly the reverse effect from steam heat; the short-wave method, incidentally, does away with cracks and expensive hand-filling-in later on.

THE RADIO MONTH

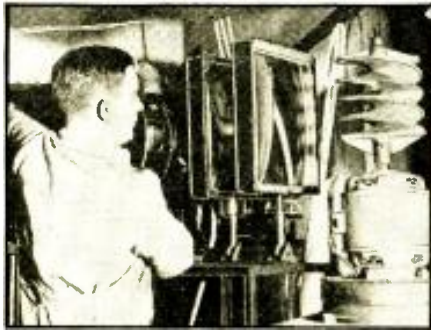

The new (European) TeKaDe mirror-screw television receiver which gives enlarged images.

NEWS IN TELEVISION

TELEVISION, which, to the radio world, outside of the research laboratories, was dormant for so long, has now bloomed forth and is one of the fastest-moving branches of the electronic art. A few of the high-lights of last month's developments are given:

The Bell Telephone Labs. announced a new tube, a dual pentode for ultra-high-frequency amplification and oscillation, which will greatly aid transmission on the "television" frequencies.

Pope Pius XI made known that a television transmitter would be erected soon in the Vatican to enable the world to see important functions of the Papal State.

The Radio Center in Moscow reported that plans had been completed to build a "Television Center" operating on ultra-short waves at 343 lines.

The Japan Broadcasting Corp. in Tokyo will start construction on a \$60,000 television transmitter, according to a statement from Dr. K. Takayanagi, director of television research in Japan. It is planned to make a complete television coverage of the 1940 Olympics to be held in Tokyo:—Germany take note!

The Telefunken Co. was able, by means of a new tube, to demonstrate television pictures projected on a wall 3 x 3½ ft. last month. The new tube is very small, flat on the end and has an aperture of 2 x 2½ ins.; the accelerating voltage is 20,000.

ROUND TWO? ASCAP vs. WARNER

ONLY 2 short months ago, the Warner Brothers music publishing subsidiaries decided to "bury the hatchet" with the Society of Composers, Authors and Music Publishers, in their fight over royalties received.

Evidently the peace was short-lived though, for as soon as Warner Bros. received their first check for royalties under the reinstated agreement, they set up a howl in the form of a stinging letter printed in *Variety*. The fight is on!

And almost coincidentally with Warner's threat to go to court, if necessary, came an announcement from the Columbia Broadcasting System that they have hired 6 American composers to write music specifically for the air. While no reference was made to the copyright fight, it is evident that CBS is not going to be caught napping as they were at the end of 1935 when the first fight started!

NEW YORK WORLD'S FAIR 1939

ACCORDING to information released last month by the authorities in charge of planning the gigantic World's Fair which will be shown in New York in 1939, radio and the electronic art will play an outstanding part in making this huge undertaking a success.

Not only will there be a section devoted entirely to the subject of communication in all its forms but many of the scientific and commercial exhibits themselves will function by reason of their vacuum tubes, photocells, etc.

And to further insure that radio and allied arts are given their share of the display, 2 men, high in the ranks of executives in the radio and communication fields are already linked to the Fair as members of the financial and design boards. These men are: David Sarnoff, President of RCA; and, Walter S. Gifford, President of A.T.&T.

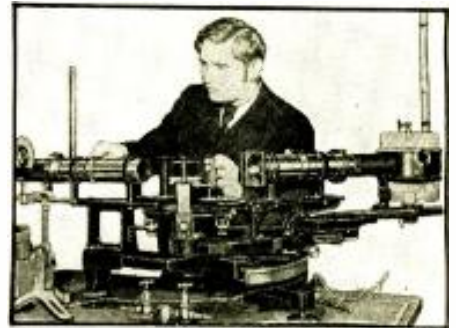

Dr. Lange with his photoelectric spectro-photometer —one of many PE. developments.

DR. BRUNO LANGE VISITS U.S.

DR. BRUNO LANGE, an eminent physicist and member of the Kaiser Wilhelm Institute in Berlin, who developed the much publicized experiment of transforming energy from the Sun directly into electricity by means of cuprous-oxide cells, away back in 1926, visited the U. S. last month to conduct a lecture tour.

By using multiple cuprous-oxide cells, Dr. Lange was able to turn small motors and light electric bulbs directly from the rays of the Sun.

RADIO—THE PIED PIPER IN REVERSE

THE editor of *World Radio*, organ of the British Broadcasting Corp., told a story of a modern Pied Piper, in reverse—last month. We quote:

"A correspondent in Denmark tells me of a farmer in that country whose farm has been plagued by rats. He managed to get rid of these annoying animals in a novel manner. He conceived the idea of trying the effect of broadcast music on the animals. He had loudspeakers installed in the barns and stables and kept them going regularly. After a few days the rats disappeared. The farmer said he believed the chamber music proved to be the last straw."



Photo of a model of the \$125,000,000-Fair grounds (covering over 1,200 acres) with the Communications Building, which will house all the radio displays, circled.

IN REVIEW

Radio is now such a vast and diversified art it becomes necessary to make a general survey of important monthly developments. RADIO-CRAFT analyzes these developments and presents a review of those items which interest all.

CBS TO HAVE NEW HOME

IN 1939—the year of New York's World Fair—the Columbia Broadcasting System will erect on Park Avenue between 58th and 59th Streets, New York, a new landmark, according to an official statement last month.

This building—which will be designed exclusively for the complete operation of a radio network—will house all the terminal equipment of this nation-wide broadcast system.

According to the statement from CBS, this radio headquarters will contain every improvement of the last 3 years and every invention of the next 3 years (television, perhaps?).

THE BOWDOIN-KENT'S ISLAND EXPEDITION

THE expedition of the ship *Scientist* to Kent's Island in the Bay of Fundy which we announced several months ago was completed, last month.

In general, the voyage was a success, as the meteorological station was set up on the island—serious magnetic disturbances which present a source of danger to navigation in the bay were investigated, until bad weather prevented a completion of the study—many feathered visitors to the Island were "banded" for later identification—and many field tasks in which the 5-meter portable radio equipment proved extremely valuable were undertaken.

Due to the excessive humidity which at times was as high as 90 per cent, some of the scientific instruments taken along were rendered useless. The *Scientist* often had to rely entirely on radio communication to find its way back to the Island through the fog, thus proving the effectiveness of radio for such purposes.

Two men were left on the Island to care for the observatory which is under the direction of the Harvard Meteorological Observatory.



The short-wave equipment on the "Scientist." This equipment was often the sole contact with the outer world.

F.C.C. RADIO SET STATISTICS

A REPORT received last month from the Federal Communications Commission contained some interesting information for radio men in general.

In brief the report states that more than $\frac{1}{4}$ of all the radio sets now in use in the U. S. are 6 years or more old, while only about 4 out of every 100 were made last year. Of the sets in use, $\frac{2}{3}$ have 5 to 7 tubes, $\frac{1}{4}$ have 8 or more tubes while only 6 out of every 100 have 4 or less.

STOREKEEPER ARRESTED FOR TURNING-OFF RADIO

BECAUSE he turned-off the radio receiver in his coffee shop during a speech by Chancellor Adolf Hitler, Ludwig Schopp a baker of Stuttgart, Germany was deprived of his tradesman's license and placed under arrest, one day last month!

Subsequently, various charges were brought against the baker by the secret police, according to news reports.

The *New York Times* published an item last month which read as follows: "The Hitler Youth organization, by arrangement reached with a broadcasting chain in the United States, will conduct a series of broadcasts for American youth this winter. The radio chain will organize an exchange of youth broadcasts between America and Germany.

"The arrangement was made by Superior District Commander Cerff, who visited the United States as the Reich's Deputy Youth Radio Director to study American radio methods of appealing to adolescent audiences.

"Whether special programs of an unusual type are to be worked out here for the American chain's youthful audience has not been announced."

Queries at the chief broadcasting companies revealed that they know nothing about such arrangements.



Two members of the Bowdoin expedition using a 5-meter transceiver to communicate with the ship "Scientist."



Russian children listening to their lessons on the "phone" teacher unit.

RADIO—THE DX PREXY

RADIO has been suggested as a desirable education medium from time to time and, in fact, is used to some extent for this purpose in the United States and in some other countries.

However, news came to us last month that in the remote parts of U.S.S.R.—and in Siberia—a similar system is being used as the entire means of educating children. The lessons are sent over telephone lines to the various outlying districts and small vacuum tube amplifiers and loudspeakers are used to increase the volume of the lecturers' voices so that groups of children can hear.

The children gather in the village meeting hall or similar place where the equipment has been installed. This provides the necessary planned educational program without the cost and difficulty of maintaining teaching forces in these remote villages which often have but a few children.

WJZ TOWER BURNS WORKMEN

AN interesting case of absorption of power in a resonant circuit occurred, last month, in erecting the new 640-ft. antenna tower for station WJZ at Bound Brook, N. J.

The new antenna tower which is located near the old one will be a 3-cornered affair, the entire weight resting on a single porcelain insulator. As the steel sections were added, the structure approached nearer and nearer in resonance to the frequency of the station. As a result, the transmitting characteristics of the station were being seriously affected, and what is even

(Continued on page 423)

ULTRA-ULTRA-MICROWAVE "RADIO" OF THE FUTURE

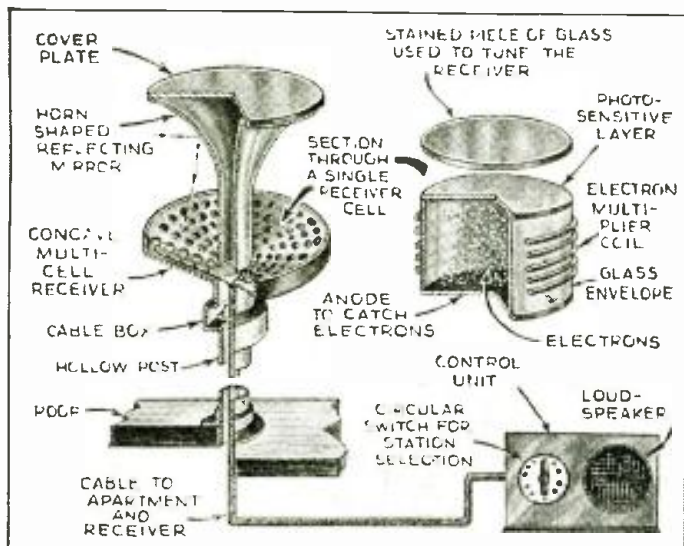

Fig. A. The waves will be "detected" without ordinary tubes.

IT IS common knowledge that radio waves, like those of light, are electro magnetic in nature. Expressed in the language of the man in the street, this means that both consist of electric particles. The only difference between them is the number of "wave-movements" per second executed by the "electric particles." Or as a technician would express it: the only difference between these two kinds of waves is in their frequency.

What this relation actually involves will become more impressive later, when we learn more about the electro-magnetic wave-spectrum, and when we consider the fact that radio (or, as the scientists call them, Hertzian) waves go down to a wavelength of about 0.01-centimeter (4/1,000 of an inch).

ULTRA MICROWAVES

Nobody, as yet, has been able to generate radio waves of such an extremely short wavelength (or, at least, not in considerable quantities), but there is no doubt that, in the future, someone will surprise us with the news that he has found a method to construct a transmitter which can generate these Ultra-Microwaves—as we shall call them, since there is as yet no official name given to them.

A very good indication that many scientists around the globe are paying attention to these very short waves lies in the fact that our daily papers have so often had rumors of that bugaboo of man—the so-called "Mystery Rays." According to these reports, this "secret brain-child" of science is undergoing intense research in one or another well-known laboratory; but the explanatory stories told by some papers are of quite frightful nature.

Inquiries at the laboratories, mentioned in these "baloney" articles, naturally provoke stern denials in each case. However, they do not change a bit the real situation, despite the fact that these sensational stories are written by reporters who do not know what it's all about. But, since the things they write about are *mysteries* to them, these pseudo-science-writers speak and write about "mystery" rays. Science, however, does not know and does not like "mysteries." Science knows only of known and unknown *facts* and, naturally,

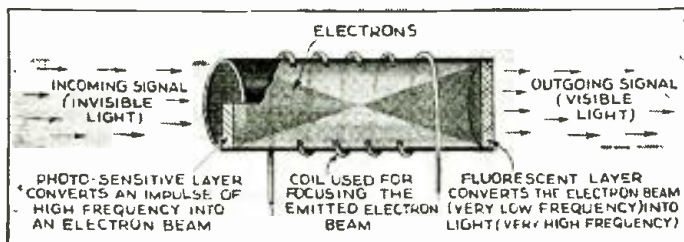

Fig. B. This tube converts "invisible" light into visible rays.

The "black gap," referred to by a well-known scientist, in describing those extremely high frequencies about which we know so little at present, threatens soon to become one of the most important bands of radio communication, if the premises set forth by the author prove to be true. The methods described are, of course, products of the imagination, but

W. E. SHRAGE

makes an effort to find out more about the latter.

The real story about these so-called "mystery rays" is the fact that the laboratories mentioned in the sensational articles are either occupied in learning more about the creation and application of very short radio waves, down to 0.01-centimeter or "cm." (see Fig. 1); or they are investigating the wave-range between 0.01-cm. (Hertzian waves) and 0.00008-cm. (red or low-frequency end of the spectrum of visible light rays) of which little is so far known. (The dimension 0.00008-cm. is, as Fig. 2 shows, a tiny part of an inch, or exactly 1/31,777-in.)

Despite the fact that 1/31,777-in. is not much to talk about, let's take a chance, and look into the wave-range, even below 0.00008-cm. At first it may seem unbelievable to some readers; but all of us are very well acquainted with this wave-range, and what's more, *we know it very well* down to 0.00004-cm. wavelength! But this is not all. Each of us is endowed at birth with means to receive these tremendously tiny ultra-ultra-microwaves!! The story of this means is not without a tragical note, for, if friends of ours have trouble with their "receiver" we say: "What a pity, he (or she) is *blind*." Or in case distortion occurs in their "reception," we call them "near-sighted," or "far-sighted," color-blind, etc. One does not need to be a scientist to know that this wave-range between 0.00008- and 0.00004-cm. is the one of *visible light*, as represented in Fig. 1; note, however, that the frequency limits used in this illustration are not at all arbitrary ones, in fact, may even overlap.

GOVERNMENTS ARE BACKING RESEARCH

Our discussion has shown us, so far, that we know approximately what to expect in the wave-range of the shortest of the radio waves, down to 0.01-cm. We all are quite familiar with the very much shorter waves of the visible spectrum, as we have seen. But we do not know very much about that portion of the wave spectrum between the shortest radio waves (0.01-cm.) and the visible light waves.

As we mentioned before, science does not know much about this space or gap—at least, not from the point of radio communication—but there is plenty of research going on in

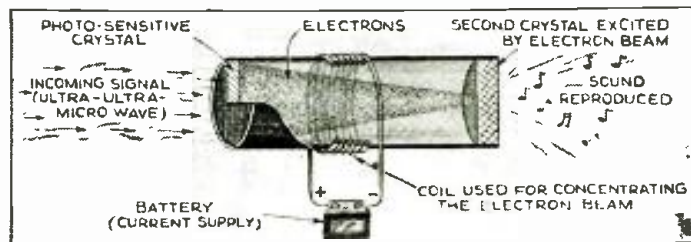

Fig. C. The principle of Fig. B. can be used to produce "sound."

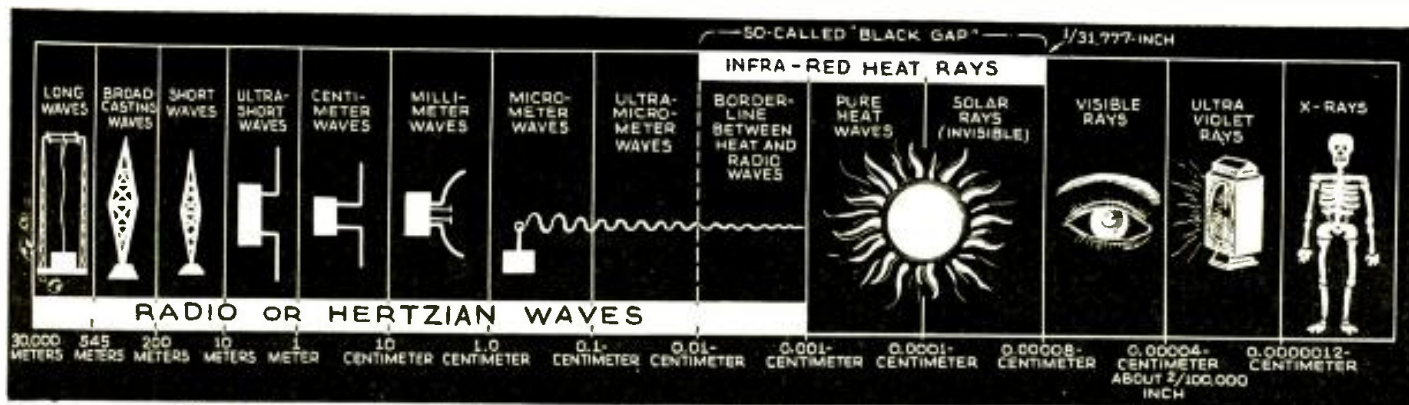

Fig. 1. The wave spectrum (not in true perspective) showing the "black gap" with relation to other electrical waves.

various parts of the globe to find out more about it.

And, what is, perhaps, most interesting is the fact that many of these laboratories are owned by governments which are pleased to give scientists "with promising ideas" a room in their research institutes (of course, a room with hermetically closed doors). The reasons for this great interest are the armies and navies which hope to find in this unknown realm of the wave spectrum something which will make a future war more terrible and creepy.

THE FIGHT ABOUT THE "BLACK GAP"

So far European "science sponsors" have been heavily disappointed, because there seems to be nothing in this gap "full of darkness" which can be used to give war machines more power to destroy. The European scientists, too, had disappointments of their own. They followed their commercial instincts, instead of considering their scientific eminence, and, in the hope of someday finding something in this unknown part of the wave spectrum which could be sold eventually to munitions makers, etc., did not publish the results of their research.

In the meantime, American scientists, concerned in this "black gap" only for its scientific interest, have not only published all the facts they found, but also have blocked the way to the patent office for many of the European inventors and scientists by applying, themselves, for the patents in question!

This happened about a year ago. Since then, European scientists have been very busy in their scientific publications "telling the world" they did everything long before America even thought of these things! But that's their own trouble. The interesting points in this fight for fame are, so far as we are concerned, the facts unveiled.

THE PHOTOCELL—THE STARTING POINT

As we mentioned before, light waves and radio waves are one and the same thing, but only different in the number of wave-movements executed per second, and their wavelengths. The elementary proof that this is true is found in the photoelectric cell. Experiments with these cells have indicated that an electron emission can be obtained by directing a light beam, as shown in Fig. 3, upon the photo-sensitive layer of a photocell.

The photoelectric cell is, therefore, (to speak in terms of radio technique) nothing but a converter, so to speak, somewhat akin to the mixer-oscillator stage of the usual superhet. Now, let us look a little closer into the similarities of these devices.

The (combined) mixer-and-oscillator stage of the usual

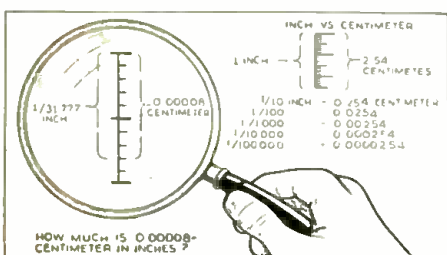

Fig. 2. The comparison of centimeter and inch.

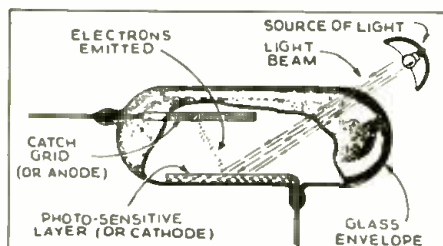

Fig. 3. The principle of the photoelectric cell using a reflecting cathode, and an anode rod.

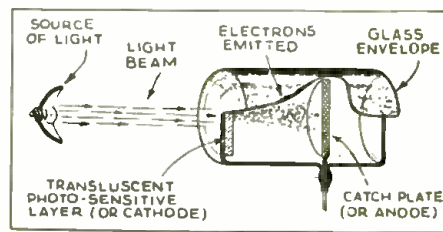

Fig. 4. A photocell having a translucent cathode which permits light to "pass through."

superhet. converts an incoming signal of radio frequency (R.F.) into a signal of intermediate (lower) frequency (I.F.). The signal remains the same, but the "form of propagation" changes. About the same thing happens when we change from an express train into a slowly-moving local train. A somewhat similar action happens in a photoelectric cell. A light beam (i.e., an impulse of an extremely high frequency) is converted into a direct-current impulse (change of "speed," but signal characteristics remain the same).

This complex conversion happens because the thin chemical layer of a photoelectric cell acts not only as a converter, but also as the 2nd-detector, and all by means of a tiny bit of caesium oxide. By mixing this alkali with other chemicals it was possible to extend the sensitivity of the photocell far into the wave-range of the infra-red rays.

Later on someone found out that the photoelectric effect can also be obtained when the light beam is thrown, not in the "regular manner" (directly onto the front of the photocell, as in Fig. A) but also upon the opposite side (as shown in Fig. 4) if only the photo-sensitive layer is made thin enough to be translucent.

Another important step was taken following an idea, first conceived by Dr. Zworykin of RCA; namely, to shoot the electrons which were obtained from a photoelectric cell (with a translucent photo-sensitive layer) directly upon a fluorescent screen (see Fig. C). How such a fluorescent screen operates is well known from the cathode-ray tube, where an electron beam falling upon the fluorescent screen causes an effect which is referred to as a *fluorescent light*. This design of Dr. Zworykin's may be called an impressive triumph of modern science over nature's secrets, because he made it possible to receive invisible "light" in the form of infra-red light and convert it into visible light. This invention, when applied in the realm of shipping and the navy, means that it is now possible to see through fog, because infra-red light is not so readily absorbed by fog.

A NEW KIND OF RECEIVER

But this is not all that makes Dr. Zworykin's invention so important; he has also opened a way by which the enormous number of frequencies in the famous "black-gap" can be used for communication, especially for television transmission.

To understand the full importance of the new device for future radio communication, let's look again at Dr. Zworykin's wonder-tube, and compare it with a radio receiver of usual design. This comparison will give us an

(Continued on page 421)

NEW DEVELOPMENTS IN SHORT-WAVE RADIO

S.-W. MOTOR-CYCLE POLICE

YOU see illustrated, below, the newest in radio-equipped motorcycles (a bicycle of course may be similarly equipped) for the minions of the Law. This is the "1937" set-up; but what will "1938" offer? In many parts of the United States large areas are policed ex-

clusively by motorcycle policemen who, in an emergency, whiz from place to place in almost nothing flat! A few seconds saved may mean apprehension, for, TIME is crime's greatest foe! A practical 2-WAY RADIO SYSTEM, such as RADIO-CRAFT'S artist has shown, in colors, on the cover of this issue is to be desired as a means of almost instantly receiving AND TRANSMITTING vital police data. An ultra-short wave "transceiver" (2-way radio set), with a microphone that operates reversibly as a loud-speaker (see November RADIO-CRAFT, pg. 272), is depicted. This magazine predicts that soon, perhaps by this time next year, some such set-up will be in operation; just as, throughout the country, 2-way "radio prowl cars" are now in use. It is impossible to stress too greatly the importance of 2-way radio equipment as a means of maintaining immediate and continuous contact between police agencies.

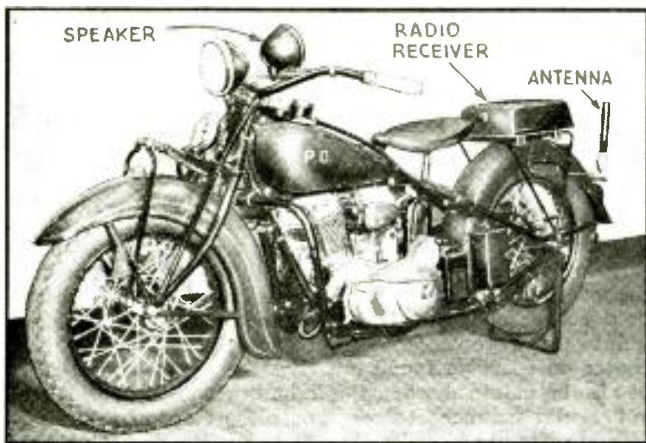

TRAIN S.-W. RADIO

FRANCE now has short-wave transmitting and receiving equipment installed on trains in service between Rouen and Paris. As shown, above, a doublet antenna system is installed on the locomotive. The system was instituted as a means of affording communication, almost instantly, between train crew and signal stations nearby but beyond sight or sound. It's said to be working perfectly. Although such communication facilities may be desirable on passenger trains, the major merit of the present set-up is in freight service.

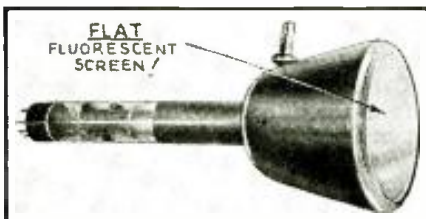

NEW HIGH-INTENSITY CATHODE-RAY TUBE EFFECTS TELEVISION THEATRE

BERLIN (Germany) movie theatres plan to present, as an intermission novelty, televised news events in screen size. An entirely new design in cathode-ray tubes has made this possible. The Telefunken Co. has accomplished the seeming impossibility in producing a cathode-ray tube (shown at upper left) that, with 20,000 volts, is so intensely bright it cannot be observed, at the flattened end, without injury to one's eyes; and permits enlargement through the usual lens system to a screen size of 3 x 4 ft. Previously, too, cathode-

ray tubes were curved on the end to withstand the several tons (total) pressure exerted by the outside air. As this curvature was a serious source of aberration in projection-type television, a new glass, developed in the United States, is used; and ground absolutely flat! Front and rear views of the theatre unit appear below.

The new "high-intensity" type cathode-ray tube that makes this "television theatre" possible, with definition of better than 400 lines, if desired, is shown in hand (left), and housed (right).

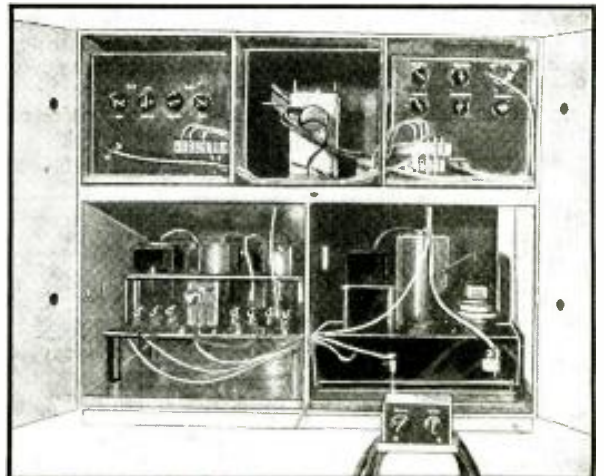
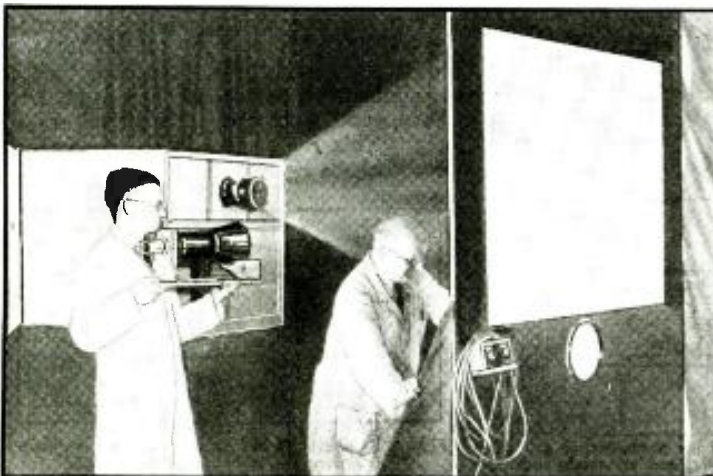

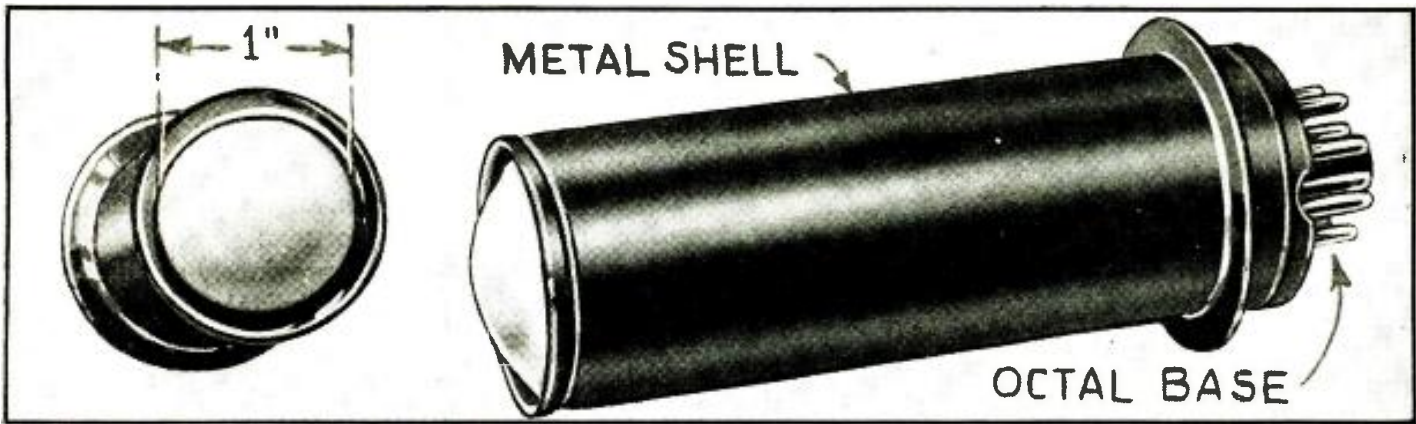

Fig. A. The full size and appearance of the new RCA 913 metal cathode-ray tube—the fluorescent end is only 1-in. in diameter!

NEW TUBES FOR THE NEW YEAR

A new metal cathode-ray tube, a critical-distance tube, and several high-frequency types for transmitting and receiving.

J. H. GREEN

WITHIN the past month several new and unusually interesting tubes, both for short-wave enthusiasts, experimenters, Service Men and radio men in general, have made their appearance on the American and European markets.

The "1-in." 913 "Metal" Cathode-Ray Tube. First, there is the new RCA octal-base "metal" cathode-ray tube, housed in a tubular metal shell of the type used for the 6L6 tube, but having a convex glass end hermetically sealed to the metal. This tiny replica of the large "C.-R." tubes is shown *full-size* in Fig. A; it will find many unusual and interesting applications.

For example, because of its small size and low voltage requirements, it can be incorporated in portable service instruments so that "visual alignment" will be possible "on the job" as well as in the service lab. Then, the tube can be used as a sort of "super"-tuning indicator

tube, which will be infinitely more effective than the previous cathode-ray indicator tubes. By adding a suitable lens, the 1-in. image can be enlarged so that this "metal" cathode-ray tube can be used for all the voltage, current, waveform, phase displacement and other applications of its larger 3-in., 5-in. and 9-in. brothers (on a diminutive scale, of course).

The characteristics of the new 1-in. cathode-ray tube, to be known as the type 913, are listed below.

913 Characteristics		
Heater Voltage (A.C. or D.C.)	6.3	V.
Heater Current	.6	A.
Fluorescent Screen Material	Phosphor No. 1	
Direct Interelectrode Capacity:		
Control Electrode to all other Electrodes	10.3 max.	mmf.
Deflecting Plate D ₁ to Deflecting Plate D ₂	3.55 max.	mmf.
Deflecting Plate D ₃ to Deflecting Plate D ₁	4.25 max.	mmf.
High-Voltage Electrode (Anode No. 2) V.	500 max.	V.
Focusing Electrode (Anode No. 1) V.	125 max.	V.
Control Electrode (Grid) V.	Never positive	
Grid Voltage for Current Cut-off	-50 approx. V.	
Peak Voltage between Anode No. 2 and any Deflecting Plate	250 max. V.	
Fluorescent Screen Input Power/sq. cm.	5 max.	milli-W.
Typical Operation:		
Heater Voltage	6.3	V.
No. 2 Anode Voltage	250	500
No. 1 Anode Voltage	45	90
Grid Voltage	Adjusted to give suitable luminous spot	
Deflection Sensitivity		
Plates D ₁ and D ₂	.15	.07 mm per volt D.C.
Plates D ₃ and D ₁	.21	.10 mm per volt D.C.

CRITICAL-DISTANCE TUBE

The Harries Tube. Next, there is the "Harries critical-distance tube" which has just been placed on the English market. This tube is a beam power tube of the tetrode type which accomplishes

(Continued on page 424)

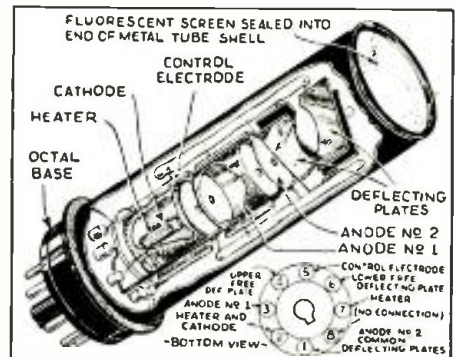

Fig. 1. The arrangement of elements in the 913.

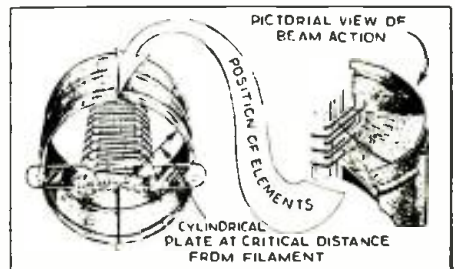

Fig. 2. The action of the Harries beam tube.

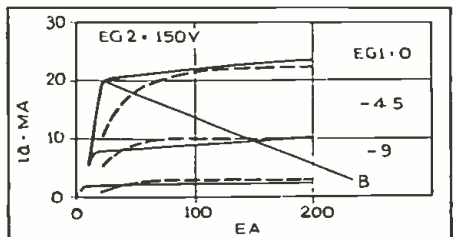

Fig. 3. Comparison of Harries' and pentode tubes.

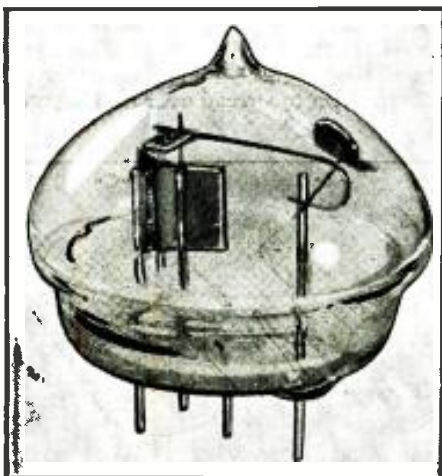

Fig. C. The W.E. 316A 0.4-meter, baseless triode.

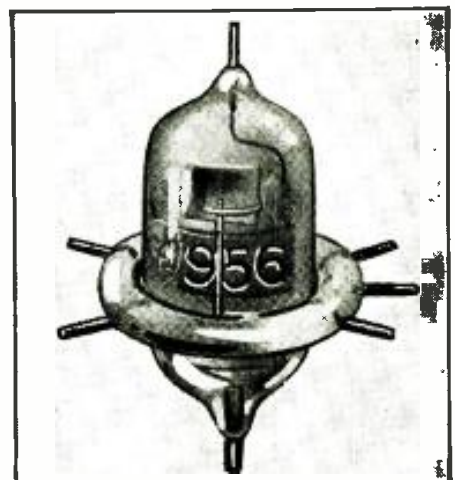

Fig. B. Variable-mu, 0.7-meter pentode "acorn."

GRIDLESS vs.

Ever since the grid element was first incorporated in a vacuum tube it has been a dogma that all subsequent tubes be similarly constructed. The author points the way to a new era, in electron tube designs, in which the previously-discussed disadvantages of a grid are eliminated by means of a "compressor."

HENRI F. DALPAYRAT

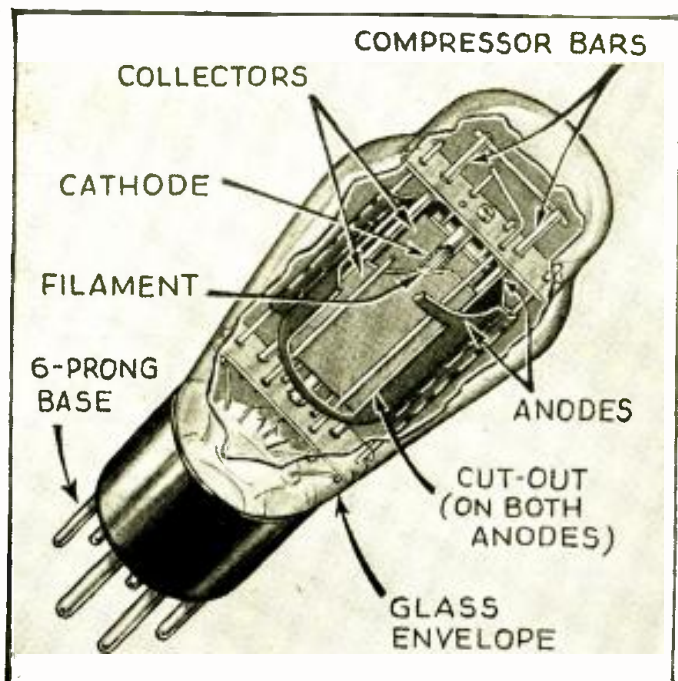

Fig. A. Phantom view of basic gridless tube; note the "compressors."

IN THE preceding issue of *Radio-Craft*, an enumeration of several disadvantages inherent in all *grid* tubes, were discussed, to point the way to much-needed improvements in electronic amplifying devices.

The new electronic principle described in the present article, and discussed in connection with *gridless* tubes, indicates the possibility of designing greatly-improved radio vacuum tubes without adhering to the conventional arrangement of electrodes.

"GRID" TUBES FUNDAMENTALLY UNSOUND

Contrary to popular belief, the standard "grid" tubes now available in the industry, although highly perfected, still have many objectionable features which cannot be corrected as long as grids are used, and which cannot be overcome by electrical circuit designs.

The source of most of the difficulties now found in thermionic amplifiers is in the tubes themselves, and it seems more logical to produce new and better tubes, rather than to improve an old and inefficient electronic technique; even though it is now generally conceded that much is to be gained by attempts to "modernize" it.

The average radio engineer, accustomed to think in terms of "grids," is inclined to take grids for granted, or as almost indispensable; though a little thought on this subject, along new theoretical principles, will disclose innumerable and important advantages derived by the total elimination of all grids!

The great number of new electrical circuits possible with the new type of "gridless" tubes (here illustrated in theory and practice) open up new fields for experimentation and invention, independent of the patent restrictions or technical limitations usually allied with well-known, well-developed standard tubes.

THE DESIGN OF GRIDLESS TUBES

One important feature of this invention is the complete elimination of the grids and their disadvantages.

Another object of the principle disclosed in these illustrations and data that follow, and the novel combinations of new electrodes in the devices, is to provide new types of vacuum-tube designs for a wider range of applications and, generally, greater usefulness than the now well-known vacuum tubes using a number of solenoid wire grids, or their perforated equivalent, concentrically positioned around a heated cathode emitting electrons.

Referring to the drawings, Fig. A shows a new type of

amplifying vacuum tube, or thermionic relay, with an evacuated envelope made of glass or metal (shown in this figure as glass) on a base having contact prongs connected within the tube to separate or similar electrodes. The centrally-located cathode sleeve is coated externally with rare-earth oxides and heated internally by a filament. Two plates in close proximity to the cathode are shown as "collectors," and two wires (rods or hollow metal cylinders) placed in spaced parallel relations with the cathode and "collectors" are the "compressor bars," within the anodes or plates, as shown sectionally in Fig. 1.

The anodes may be separate plates, either electrically connected or insulated from each other, or formed of a single tubular plate having its facing surface plates stamped out, to decrease capacity coupling between the anode and collectors.

Figure 1 (A, B and C) shows the arrangement of the tube electrodes mentioned, as seen endwise. The filament-heated, coated cathode is emitting electrons which are repelled by negatively-charged electrodes or *compressor bars*; thus forming 2 electron beams which are each attracted and collected by the positively-charged collectors; these have their positive potential regulated to be much lower than that of the anode plates. The voltage on the "collectors" is made small enough to allow the *compression* of the stream of electrons by the "compressors"; but also high enough to establish a constant electronic emission to the "collectors" or absorption electrodes.

Figure 1A shows how a high negative charge, applied on the compressors, directs all electrons towards the central portion of the surfaces of the collectors. The combined positive charge of the collectors and negative charge of the compressors completely prevents any electrons from reaching the anodes. Note the width of the electron beams, spreading over the surfaces of the collectors, in Fig. 1A; while Fig. 1B shows how these electron beams spread in cross-sectional areas, and impinge upon a larger portion of the collector surfaces when the negative charge of the "compressors" is decreased.

Figure 1C shows how a further decrease in negative potential of the compressors, or even the application of a positive charge on them, reduces the compression of the beams of cathode electrons, and allows them to spread over and beyond

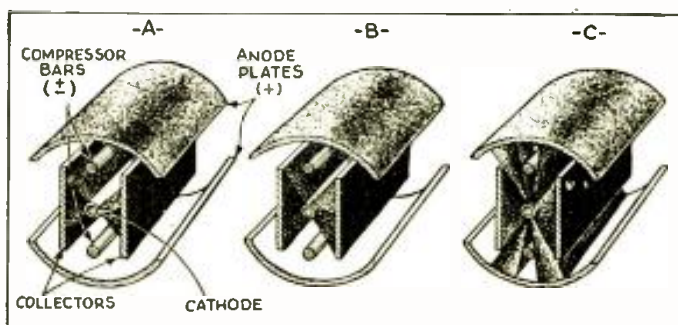

Fig. 1. Approximate representation of gridless tube operation.

GRID TUBES

By the simple expedient of arranging "compressor" elements to control by electronic means the electron emission from cathode to anode, a radically new design in electron tubes is effected. Coincidentally, many new and important functions are made available; one of the most outstanding of these is automatic noise suppression; in this design, both the above- and below-signal-level interference voltages are counteracted.

PART II

the surfaces of the collectors; thus allowing electrons to reach the anode plates in the form of 4 electron beams. These beams vary in electronic density according to the voltage variations applied on the compressors, which control the direction of the cathode electrons towards the collector plates, and vary the number of electrons either absorbed by these collectors or passing between the collectors and compressors to be received by the anodes.

GRIDLESS-TUBE CIRCUITS

Figure 2 shows how an individual A.V.C., per stage, can be obtained with the electron-beam compressor tube described above. In this I.F. (the same principle is applicable at R.F. or A.F.) amplifier, the signals are applied on the compressors, varying the electrons passing through to the anode. The D.C. potential applied on the collectors is obtained through a potentiometer R and a signal-load ohmic impedance (high resistance) R1. When the signal voltage variations, or excessive noise impulses, rise above the A.V.C. signal level, the positive potential of the collectors is increased through capacity C. The positive voltage, increasing in these collectors, absorbs a greater number of electrons from the cathode; thus diverting electrons from the cathode to the anode streams, and decreasing automatically the amplification of the tube for only the excessive amplitudes, as adjusted by the positive absorption potential obtained through R.

The addition of regeneration to this circuit through a tickler coil T, connected in the anode circuit at point (X) can be advantageously utilized for greater sensitivity, improved selectivity, or larger power output, or accentuation of certain modulation frequencies; while the voltage-controlling functions, previously described, enable this circuit to provide stable and constant automatic regeneration, a feature unusually useful in short-wave reception.

The foregoing described only a few possible applications, such as individual (per stage) automatic volume control, automatic regeneration control, and a combination diode and

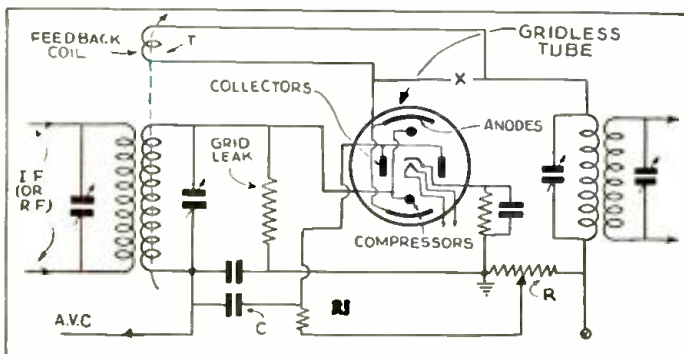

Fig. 2. Experimental circuit in analysis of gridless tube operation.

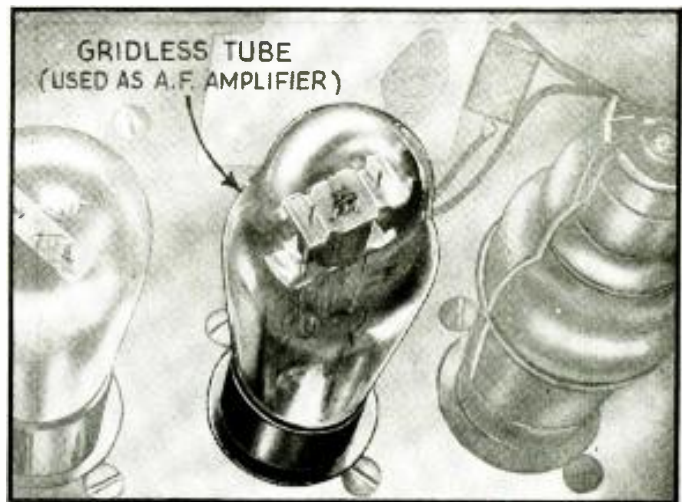

Fig. 3. Actual gridless tube in an experimental receiver.

power output amplifier tube. Other circuits, such as automatic volume control and noise suppression controls, incorporated in each stage of a receiver, in order to produce a practical "noiseless" or "static proof" receiver, will be described, exclusively and for the first time, in a future issue of *Radio-Craft*.

Referring again to the advantages of "gridless" tubes, and more particularly to the type invented by the writer and described in this article, a number of advantages will be given below.

ADVANTAGES OF GRIDLESS TUBES

It is one purpose of this invention to eliminate solenoid wire grids, and the method of passing electrons through spaces between wires, or slots, or small perforations in any controlling electrodes.

Another purpose is to simplify the mechanical construction and assembly of parts in tubes, while providing stronger, more rigid structures, and insuring the manufacturing production of tubes having uniform characteristics.

Still another purpose is to greatly decrease interelectrode capacities, and to render practical these tubes for the faithful amplification of audible frequencies, or the amplification of very short waves, or the generation of constant oscillations, etc.

The "gridless" design also provides a new vacuum tube, having inherent self-limiting amplification properties, and/or self-selecting amplitude-selection properties, or automatic current or voltage stabilizing properties, in addition to their normally intended functions such as detection, rectification, and/or amplification.

There are many other important advantages to be obtained by applying the "gridless" principle of construction to tubes of all types. Some of these features are listed, numerically, as follows.

(1) Combine, in a simple manner, several functions in one electronic device, without one function interfering with another.

(2) Permit the manufacture of simple, inexpensive, small tubes, practical for short-wave operation, and capable of delivering (as working models have proven) stable, constant, undistorted and highly amplified current.

(3) Provide new tube designs, especially applicable to power output-tube operation and capable of delivering relatively high undistorted power output, with a minimum of positive voltage applied on the main output anode.

(4) Reduce or eliminate internal vacuum-tube noises, which are due to electronic bombardments upon electrodes, or to unwanted electronic reflections or uncontrollable electronic emissions.

(5) The reduction, or the elimination, of currents in certain electrodes, in order to minimize a type of output current

(Continued on page 428)

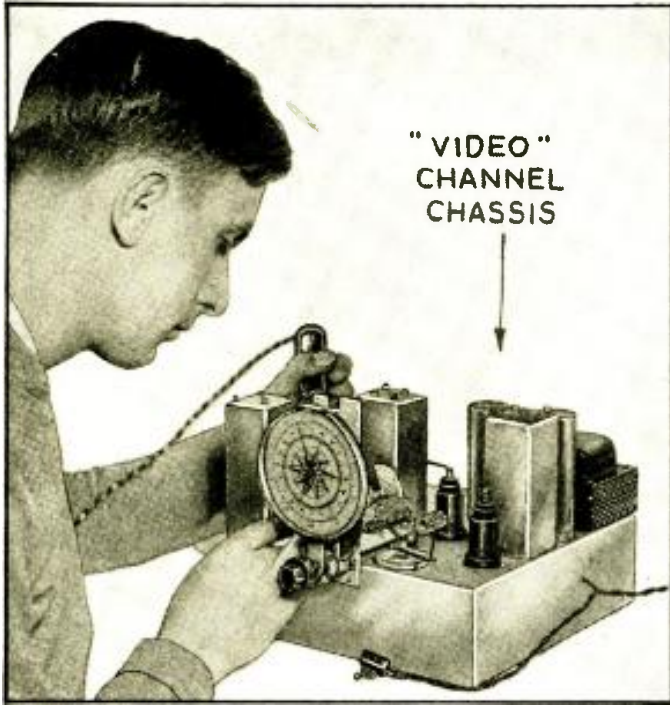

Fig. A. The video channel of the set—under construction.

HOW TO MAKE THE TELEVISION

Although television sight and sound transmission is now being conducted on an experimental basis it is only a matter of a short time until these transmissions are made available to the general public. In order to acquaint the proficient experimenter with the fundamentals of cathode-ray television design and construction, RADIO-CRAFT here offers an up-to-date instrument (parts cost not over \$100!), developed under the direction of Mr. C. W. Palmer. Images are not green-and-black but white-and-black!

PART I

THE SUBJECT of "constructing a television receiver" has, up to the present moment, been carefully set aside by the staff of *Radio-Craft*, in spite of the numerous requests which have been received from time to time from our readers who wish to play with this fascinating branch of radio.

However, with the standardization of transmission characteristics by the RMA and the constant transmissions from the Empire State Building transmitter, the Philco station in Philadelphia, the transmissions of the Don Lee network on the West Coast and other stations in the United States, even though these transmissions are on an experimental basis, has at last brought the television art to a point where there is no really sound argument against experimental work by those who enjoy "putting them together and taking them apart."

To the contrary, the historical background of radio contains so many cases where amateurs and experimenters have made worthwhile discoveries and developments that

it is high time that these men were given a little encouragement in the form of instructions for making one type of experimental receiver which can be used as a basis for experimental work.

In designing this *Radio-Craft* 1937 Television Receiver, no pretense was made at making "the ultimate" receiver. On the contrary, there is so little practical data available from which to work that the design was actually started from "scratch" and for this reason there are, perhaps, many parts of the set which can and will be improved as time goes on.

THE DESIGN

Let us consider for a moment the subject of designing a television receiver which can be duplicated by "advanced experimenters" from parts readily available on the market from stores and mail-order houses. It will be noticed that we stress the point *advanced experimenters*—since the cathode-ray television receiver uses of necessity high vol-

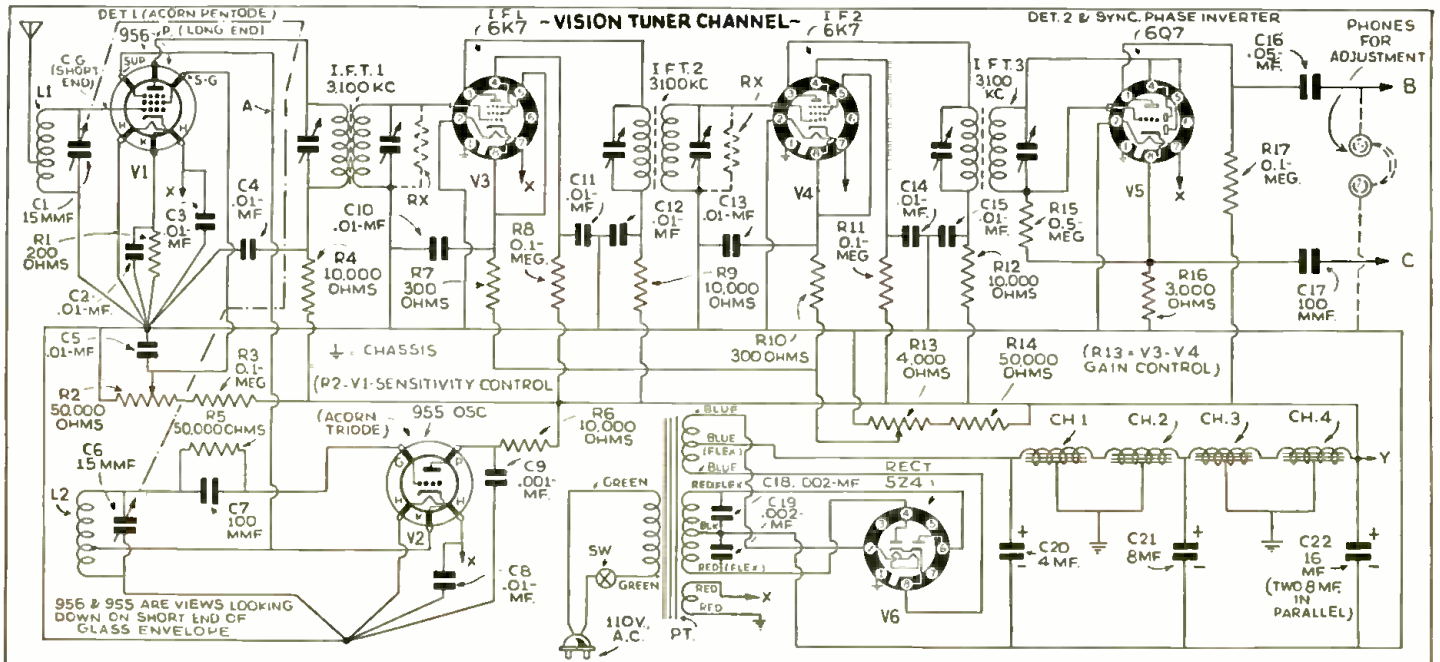

Fig. 1. The schematic of the video channel—the positions marked A, B, and C will be picked up in succeeding parts of the description.

RADIO-CRAFT—1937 RECEIVER

RMA RECOMMENDATIONS TO THE F.C.C.

The Federal Communications Commission has been so deluged with inquiries and requests for television station licenses that it has become necessary to conduct an inquiry into the possibilities of allocating channels for this purpose. Therefore, a group of engineers representing the major television interests in the U.S. under the direction of the Radio Manufacturers' Association has recently submitted a list of recommended "standards" satisfactory to these interests, so that a single set of characteristics may be used for all transmissions. Their recommendations will be found in the article, below; (their cooperation is to be commended).

The committee was composed of Messrs. F. J. Bingley—Philco; R. B. Dome—G. E.; E. W. Engstrom—RCA; P. T. Farnsworth—Farnsworth Telev.; R. D. Kell—RCA; H. M. Lewis—Hazeltine Corp.; A. F. Murray—Philco; F. J. Sommers—Farnsworth; C. B. Jolliffe—RCA.

tages for the accelerating electrodes the receiver is no plaything for an inexperienced person. Do not let us scare you off by this emphasis, though, for the voltages are no higher than those used in the Service Man's oscilloscope which is being used, safely, by many hundreds of Service Men and technicians daily.

The receiver which we are going to describe is made from parts which are now available. This limits the scope of the set, to some extent, of course, for special parts, such as tubes, etc., would without doubt permit larger, clearer images to be obtained.

And there is another important point which must be considered—that is cost. One of the factors which controlled the design of this set more than any other was the cost of material. Most experimenters have limited funds with which to build such a set, especially since it is an experimental unit and not the usual cut and dry assembling of a broadcast set which is sure to work well if it is carefully assembled.

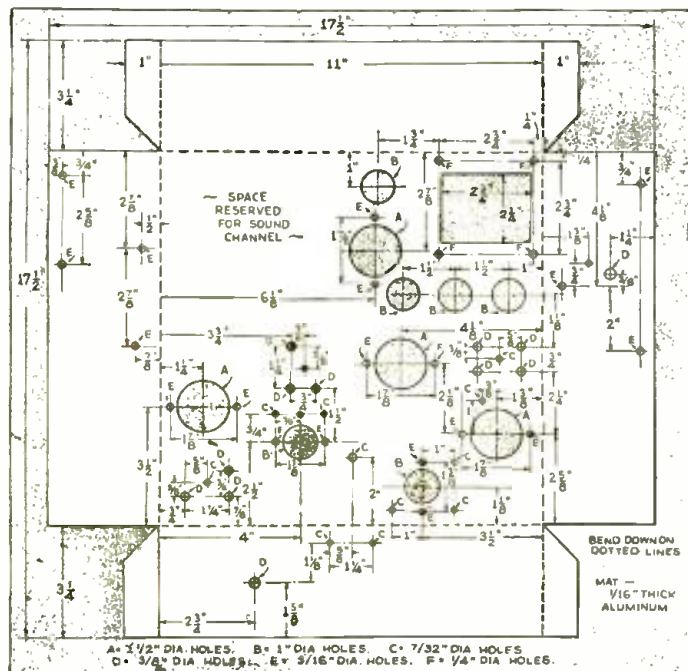

Fig. 2. The drilling layout and dimensions of the chassis.

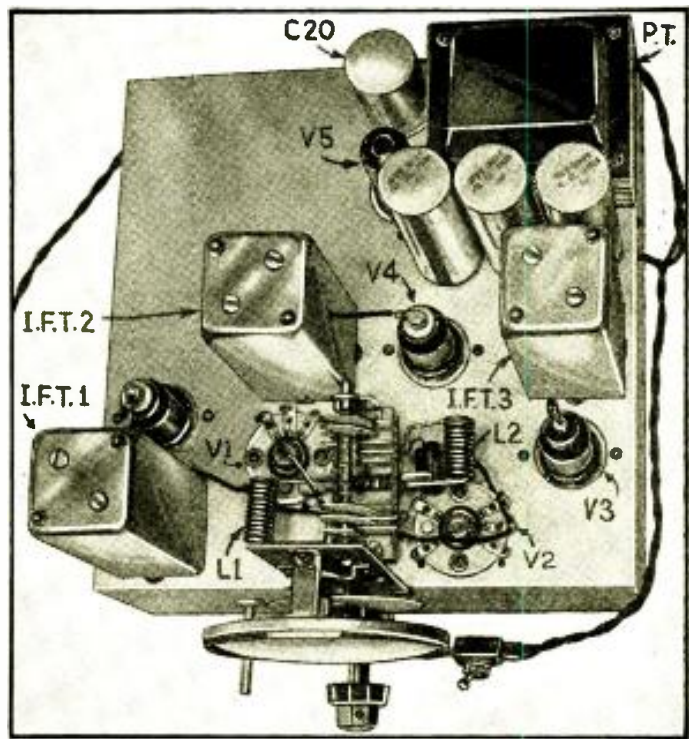

Fig. B. The top of the chassis showing the parts layout.

Therefore, we set about \$100 as the price of the parts and worked around this figure. Instead of using some 35 tubes as found in the experimental models made by some of the leading companies in their work, the number of tubes was reduced to a minimum consistent with satisfactory results. It must be remembered also that the frequencies at which television signals are being transmitted, at present, are quasi-optical in their characteristics. In other words, they can not be picked up over great distances, with sufficient strength to produce satisfactory images in a receiver. This means that those experimenters who are more than a few (some 20 or 30) miles from one of the experimental television stations must wait until the art has progressed to such an extent that they are living in the "service area" of a station (not yet built).

Our receiver has been designed particularly for reception of the transmissions from the Empire State Building—but where characteristics differ, the set is sufficiently flexible

(Continued on page 426)

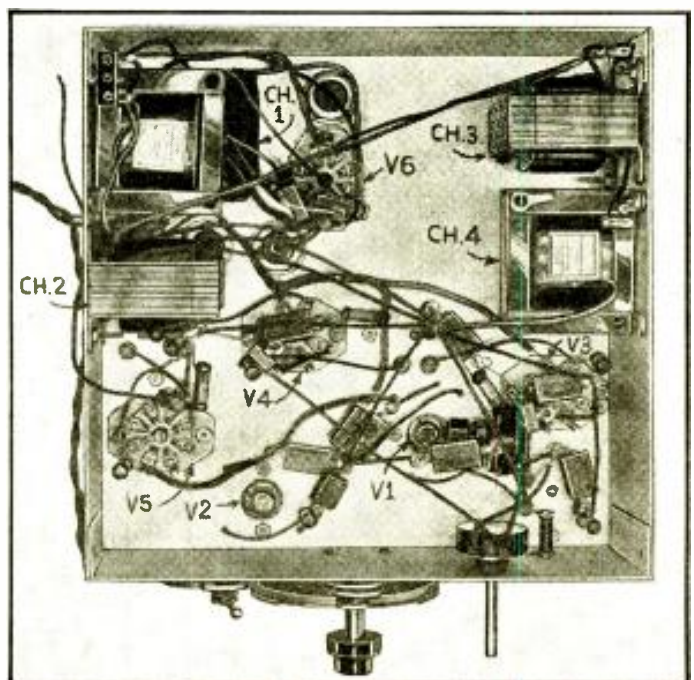

Fig. C. The under side of the chassis showing wiring.

A SIMPLIFIED FOR SHORT-WAVE

A complete, step-by-step description of the construction of an A.C.-D.C. S.-W. converter of modern design for use with a broadcast receiver.

RAYMOND P. ADAMS

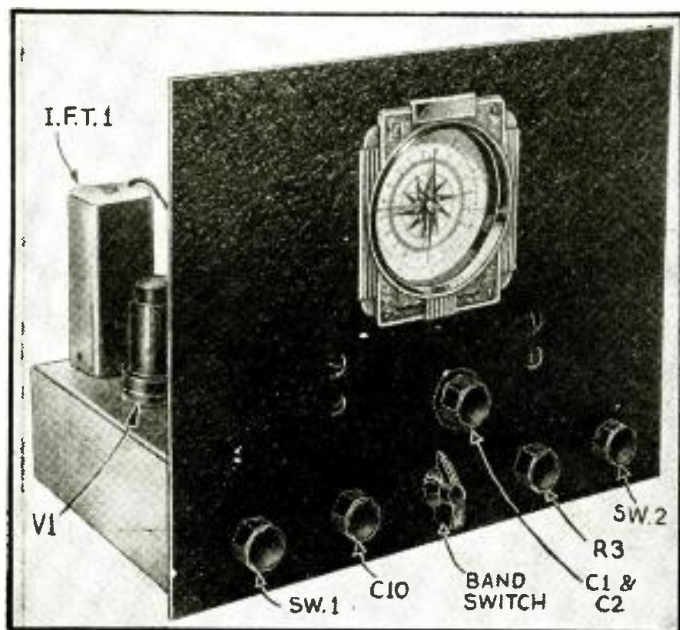

Fig. A. The panel of the converter with controls indicated.

MANY receivers still in service today are either "tuned R.F." jobs, or "superhets." covering only the major broadcast band. For many reasons, their owners are unwilling to turn in these receivers for multi-range sets of more advanced design.

Some of these receivers can by no stretch of the imagination be considered efficient—and their obsolescence or general cheapness prohibits anything more than minor repairs, let alone such a refinement as adaptation to all-wave service. Others—even some of the old-timers with 26s in the R.F. stages—are doing an excellent job of broadcast reception and well worth both thorough overhauling and the cost of a converter which will extend the tuning range down to at least 19 meters.

A practical converter for such service should have the following features:

- (1) Low first cost—properly proportioned to the value of the "average" single-band receiver in use and that of the average new all-wave set of medium cost and good efficiency.
- (2) Small size.
- (3) Self-contained power, so that it may be used with any receiver.
- (4) Universal design, so that a single band, or selected groups of bands, may be covered.
- (5) Inherent I.F. amplification, to give effective service with receivers having low selectivity and sensitivity.
- (6) Adequate image-frequency discrimination.
- (7) Highest possible R.F. efficiency and signal-to-noise ratio, with a minimum of tuned input circuits.

The instrument described herein has these 7 required features and offers a basic design which will support such further refinements as the builder may wish to add.

GENERAL DESCRIPTION

The Simplified Converter is A.C.-D.C.-operated, and has a 6K7 stage of I.F., tuned to the low-frequency end of the broadcast band. It employs separate high-frequency mixer and oscillator tubes, for highest possible conductance and a minimum of off-alignment oscillator swing with detector tuning. It obtains best possible signal-to-noise and signal-to-image ratios by using *detector regeneration*—the only effective substitute for a costly, hard-to-build tuned-R.F. stage; and makes use of a 3-gang, 6-pole switch for band switching. A miniature "minute-hand" dial affords the same tuning and logging conveniences found on expensive all-wave receivers; and controls permit both peak adjustment at all frequencies and a shift from broadcast to S.-W. operation without trouble.

The photographs show only one (general coverage) set of coils, all others having been removed for a clear view of the various components. This coil set, by the way, has the widest possible coverage (from approximately 19 to approximately 60 meters—depending upon the adjustment of the oscillator trimmer) and suggests the construction of a converter for a single high-frequency band, requiring no costly band switch. Shielding between coils has also been removed, simply to reveal points of physical construction—not to imply that such shielding may be eliminated (See Fig. C.).

THE CIRCUIT

Detector Stage. The detector is a 6L7, conventionally connected, but with its cathode-return through the usual resistor-filter condenser combination to a tap on the detector coil, rather than to ground. The screen-grid, carefully filtered, is tied to the center arm of a 40,000-ohm potentiometer across the power supply, which serves as regeneration or input sensitivity control. The cathode tap on the coil is so placed that, with the control adjusted for maximum sensitivity (maximum screen-voltage slightly less than the measured "B+") full regeneration is had without detector-circuit oscillation.

Oscillator. The oscillator is a 6C5, wired in an electron-

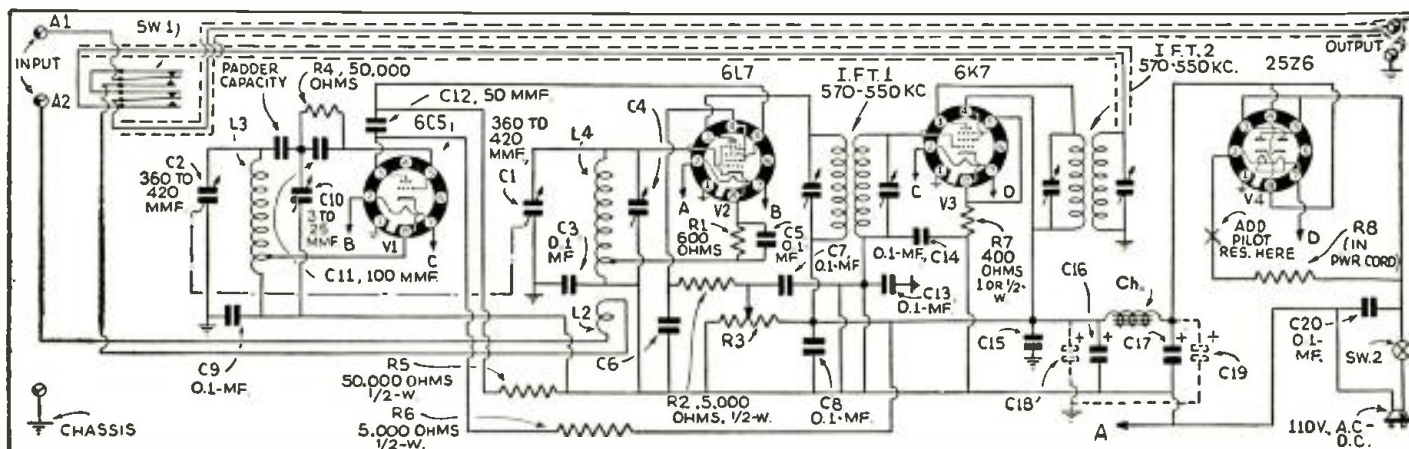

Fig. 1. The schematic circuit of the complete unit. The details for making the coils will be found in Part II in a forthcoming issue.

CONVERTER RADIO BEGINNERS

Those who own broadcast receivers which do not have facilities for tuning-in the programs on the short-wave bands will find this add-on unit to be exceptionally quiet and efficient. Complete constructional details are given.

PART I



coupled circuit for maximum stability with feed-back through the cathode tap, worked out properly for a fairly uniform oscillator voltage throughout the tuning range of each coil.

Mixing. The oscillator voltage is fed through a small capacity to the injector, or No. 3 grid of the 6L7 detector; with a 50,000-ohm resistor, R5, connected as shown.

Tuning. The variable condenser is a 2-gang affair with low minimum capacity, and trimmers removed; although they may be retained for high-frequency alignment where the converter uses but one set of coils. The maximum capacity may be anything from 360 to 420 mmf. Endeavor to obtain a condenser whose minimum capacity is not greater than 12 mmf.

The Dial. The dial is a vernier-adjustment, dual-pointer type; this type of control is a practical necessity, where wide coverage is to be expected, with a single set of coils. The converter uses a large tuning capacity, with high C/L ratio and extremely sharp tuning, over the low-frequency ranges of each coil in particular. A single-pointer dial may of course be used, but the type specified in the List of Parts permits wide spread at all frequencies and more exact logging.

The I.F. Circuit. Most converters do not provide I.F. amplification; and thus neither work well with relatively inefficient broadcast receivers, nor lend themselves to easy and accurate adjustment. By employing a single stage of moderate gain, not only is the instrument described made adaptable to receivers of wide efficiency range, but its proper line-up with these various receivers is facilitated. The converter is built to work at an I.F. of approximately 550 kc. When attaching it, then, to any receiver, it is only necessary to set the receiver dial to 550 kilocycles to assure maximum overall performance.

The Output. The converter is coupled to the receiver by matching the secondary of its output I.F. transformer to the high-impedance primary of the receiver's antenna transformer. This effects a minimum of transfer loss; especially

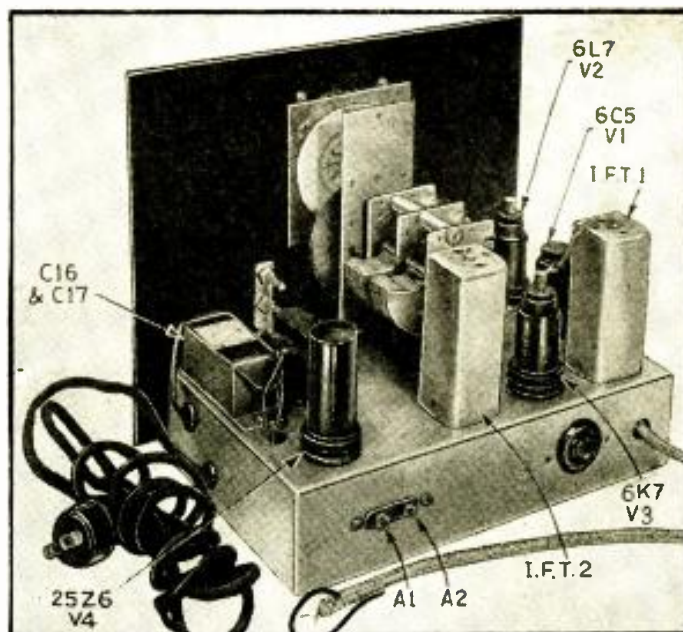

Fig. B. The rear of the chassis showing parts layout.

if the secondary can be tuned to match, approximately, the antenna coil primary. Naturally, if the receiver has a low-impedance primary, it will be necessary to take turns off the converter's output transformer secondary until a fairly close match is secured.

The Power Unit. This converter is A.C.-D.C. powered. The rectifier is a 25Z6, with its 2 plates in parallel and its 2 cathodes similarly tied. Rectification is single-end (half-wave) and a humless D.C. output of approximately 135 V. may be expected if builders use the tubes, components, and values suggested. The raw A.C. from the 25Z6 is filtered by two 8-mf. 200-V. electrolytics and a single 400-ohm choke, these values doing a perfectly efficient job at the low current drain of the 3 tubes.

Note the "B-" lead is NOT grounded to the chassis, and all returns are made to "B-" rather than to chassis; only the No. 1 terminals of the sockets, the shields, and the condenser rotors are chassis-grounded. The R.F. connection between chassis and "B-" is made through bypass condensers at the R.F. coils (grid-returns) to localize the complete high-frequency circuits, and at another point along the "B-" lead.

Provisions for Change-over. A D.P.-D.T. switching arrangement permits changeover from broadcast to converter operation. The leads from switch to receiver and from output transformer to switch are shielded in low-capacity tubing. (The importance of the former lead should be noted; the

(Continued on page 430)

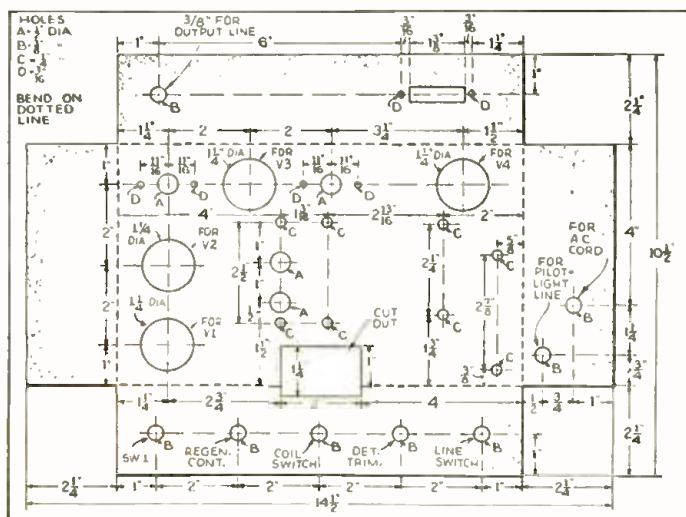

Fig. 2. Dimensions of the chassis; and drilling layout.

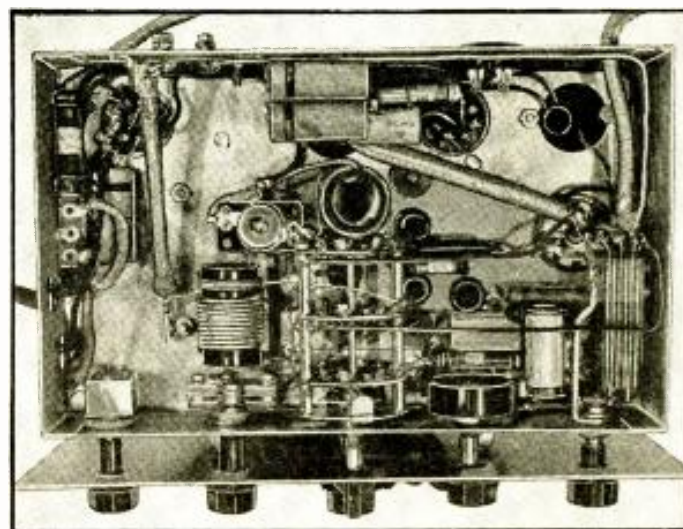

Fig. C. Underside of chassis. Note band switch and coils.



Rocky Point trans-Atlantic telephone terminal—affected by fade-outs.

SUN-SPOTS AND SHORT-WAVE RADIO FADE-OUTS

Short-wave communication has been mysteriously interrupted at intervals to the concern of all radio operators — a Mount Wilson Observatory associate tells why!

R. S. RICHARDSON.....

sion by causing sudden fade-outs lasting from 15 minutes to 5 hours, depending upon the frequency. This effect should interest radio amateurs since it is confined entirely to high frequencies, and because they can do work of real scientific value by noting carefully the time of these fade-outs. *So far as the writer is aware, Radio-Craft is the first popular scientific magazine to call attention to this unusual phenomenon.*

NATIONAL BUREAU OF STANDARDS

The effect was first noticed by Dr. J. H. Dellinger of the National Bureau of Standards. Reports had come to him of a sudden and complete disappearance for about 15 minutes ("as if a fuse had blown out") of all high-frequency radio transmission over the illuminated half of the globe on November 28, 1934, and March 20, May 12, July 6, and August 30 of 1935. He noticed that these dates are about 54 days apart, except for the first two where the interval is nearly double 54 days. It occurred to him that the fade-

(Continued on page 439)

DURING the last 15 years evidence has been accumulating that there exists some general relation between radio-wave propagation and sun-spot activity.

For example, it has been found that on the average the field strength of long-wave signals arriving from distant transmitters is closely correlated with the average number of sun-spots observed during the year! This does not mean, of course, that every time a large spot appears on the sun that long-wave signal strength increases; it simply means that the reception is generally better during years of maximum sun-spot activity and worse when sun-spots are few and far between. But just recently evidence has turned up indicating that, in certain cases at least, sun-spot activity may have a direct effect on high-frequency radio transmis-



A receiver and "disturbancegraph" with workers being instructed.

WPA POLICE-RADIO "NOISE DETECTIVES"

One of the very useful tasks of the WPA has been to track down and plot radio interference areas.

A. W. VON STRUVE.....

related in any way with the national anti-interference organization mentioned in the notation at the end of this article.—*Editor*) In the application for official approval of the project it was described as being designed "to detect electrical disturbances which interfere with police radio reception in Newark and Essex County."

Employment for 45 men and 1 woman is provided by the project. The duties of the workers will be to prepare street maps for the location and intensity of disturbances. At present, the jobs include 30 field clerks, a file clerk, 4 draftsmen, 2 typist-clerks, 2 radio repairmen, 2 junior engineers, 2 electrical engineers, a supervisor, a timekeeper, and an executive secretary (who is a woman). All the workers, qualified for the various positions, come from the relief rolls. They were required to be holders of Federal Communications Commission radio operators' licenses, or in a few instances to be established as electrical engineers.

Hiring of the office workers began in September. *A staff of radio engineers and electricians is being assembled as rapidly as men possessing the necessary qualifications can be interviewed.* The project will continue 6 months.

Field workers will be divided into 10 parties of 3 men each. Five parties will spend their time locating the center

(Continued on page 434)

"CALLING ALL—brrrpweeezowie! Calling all cars. Proceed to xhjkrzzoomwhoosh man reported blooooiee!"

No, the police radio announcer wasn't "stewed" and neither is the writer. The foregoing paragraph is merely an effort to present a word picture of what happens when electrical interference disturbs radio reception.

What causes a radio broadcast to turn suddenly from something intelligible into a blow-by-blow description of a feline battle royal is the object of a study of radio broadcasting and reception difficulties induced by electrical disturbances—man-made static—which is being undertaken in Newark and Essex County, New Jersey.

The project, financed jointly by the Federal Works Progress Administration and the City of Newark, is believed to be the first of its kind in the country. (This project is not

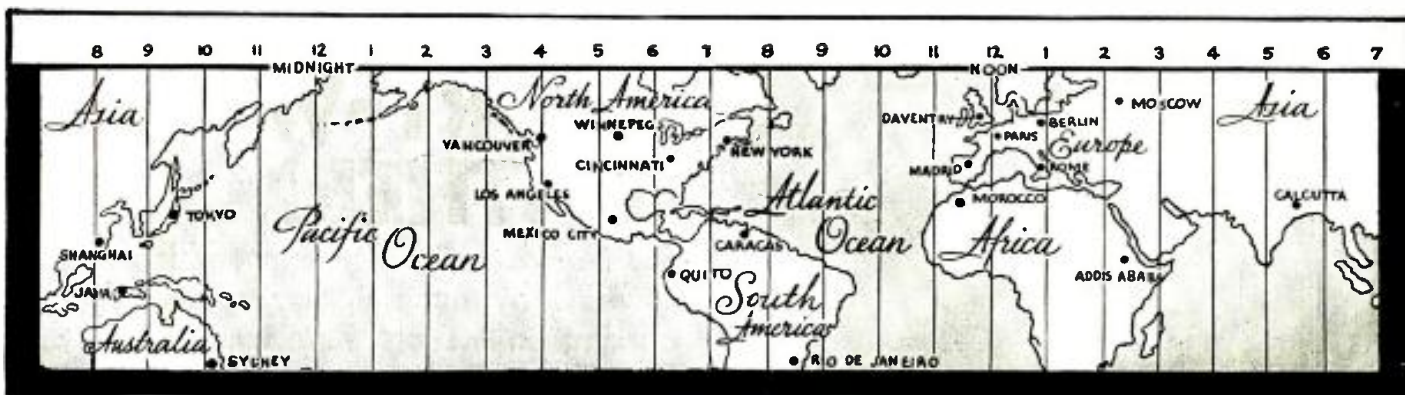

(Courtesy—Crosley Radio Corp.)

Many owners of all-wave receivers fail to obtain the maximum enjoyment from their sets because they do not know when or how to tune them on the "S.-W." bands. Service Men will find this article of help in instructing set owners and prospects.

HOW TO GET "LONG DISTANCE" ON YOUR ALL-WAVE SET

M. HARVEY GERNSBACK

A GREAT MANY of the radio sets in use in the home today are so-called "Broadcast and Short-Wave" receivers. These sets generally will cover all wave-bands from the regular broadcast band (550 to 200 meters) to about 10 meters. Some receivers of low price do not go below 19 meters and some of the more elaborate ones will cover the bands down to 5 meters. Still other receivers cover the regular broadcast band (200-550 meters) and the short-wave bands from 50 to 19 meters, completely skipping the bands from 200 to 50 meters.

METERS, KILOCYCLES AND MEGACYCLES

A great deal of confusion has been

caused by the terms *meters*, *kilocycles* and *megacycles* which are used interchangeably to denote the channels on which various stations operate. Actually they are 3 different ways of saying the same thing. No useful purpose would be served here to go into an involved explanation of the significance of these terms. Simply let it be said that they are units of measurement somewhat as a foot or yard is a unit of length.

For example, broadcast station WLW in Cincinnati operates on a wavelength of about 428 meters. Another way of saying this is that WLW operates on a frequency of 700 kilocycles. (To translate meters into kilocycles, divided either into 300,000—which is about the

speed in meters with which a radio signal travels; the dividend is the desired figure.—Editor)

The kilocycle (or "kc.") method of figuring is used more often today because it is more convenient than the meter system. The shorter the wavelength of a given station, the higher its frequency in kc. will be. A station operating on 200 meters has a frequency of 1,500 kc. while one on 10 meters has a frequency of 30,000 kc.!

When dealing with these short-wave (or higher-frequency, if you wish) stations, the use of kilocycles becomes a nuisance. For example, a certain station operates on 25.53 meters. This is equiv-

(Continued on page 440)

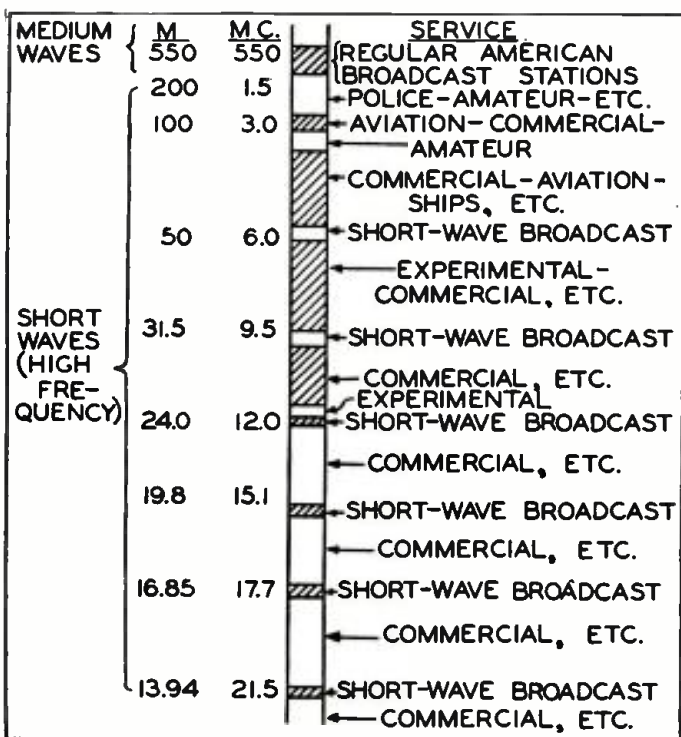

Fig. 1. Frequency chart of relative positions of S.-W. stations.

FREQUENCY	LOCATION OF STATIONS	TIME OF DAY IN E.S.T. FOR BEST RECEPTION.
30-20M C.	EUROPE SOUTH AMERICA ASIA & AUSTRALIA	7 TO 11A.M. 11A.M. TO 2P.M. 3 TO 6P.M.
20-17M C.	EUROPE ASIA & AUSTRALIA SOUTH AMERICA	7A.M. TO 1P.M. 2 TO 6P.M. 10A.M. TO 3P.M.
17-13M C.	EUROPE ASIA & AUSTRALIA SOUTH AMERICA	5A.M. TO 9P.M. 11P.M. TO 9A.M. 7 TO 9A.M. 4 TO 7P.M.
13-11M C.	EUROPE ASIA & AUSTRALIA SOUTH AMERICA	4P.M. TO 5A.M. 10P.M. TO 3A.M. 6A.M. TO 9A.M. 5 TO 7A.M. 6 TO 8P.M.
11-8M C.	EUROPE ASIA & AUSTRALIA SOUTH AMERICA	4P.M. TO 4A.M. 4 TO 9A.M. 5P.M. TO 7A.M.
8-5M C.	EUROPE ASIA & AUSTRALIA SOUTH AMERICA	10P.M. TO 2A.M. 5 TO 7A.M. 7P.M. TO 5A.M.

Fig. 2. The best times (E.S.T.) to listen for short-wave stations.

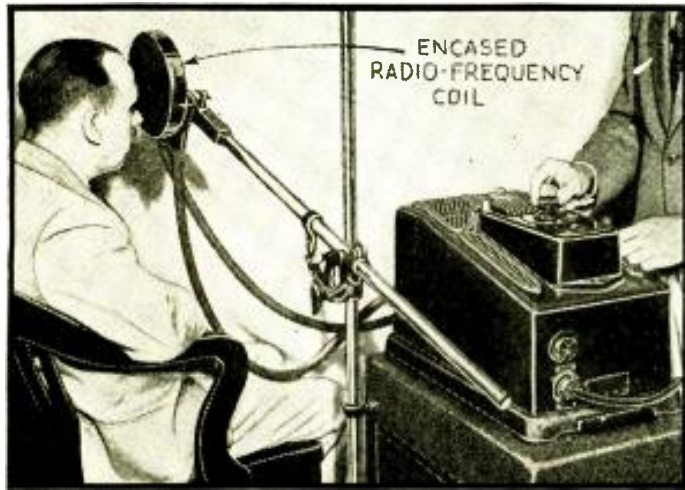

Fig. A. A G.E. 25-meter "inductotherm" in operation on a patient.

MODERN SHORT-WAVE DIATHERMY

Short-wave radio diathermy, which was discovered by accident by radio engineers working on a short-wave transmitter which caused them to have an artificial fever—has developed into a useful and humanitarian science—as described.

LEON C. BUNKIN.....PART I

THE SCIENCE of physio-therapy today embraces in its scope a comparative newcomer to the field of therapeutic treatment. It is the *short-wave diathermy machine*. Since so many of the medical profession are using this new machine for therapy, or have evinced a keen interest in its probable efficacy, the following complete summary on the subject should not be untimely; this summary has been checked by eminent hospital and private practitioners of radio therapy. Service Men and other radio technicians should familiarize themselves with the fundamentals here outlined.

WHAT IS DIATHERMY?

Just what is *diathermy*? In a few words, diathermy is the heating of the body tissues by a high-frequency electrical field. And there is nothing new about that. The therapeutic use of heat is as old as the sun itself. In recent years research has convinced the world of medicine that fever itself is a therapeutic agent of nature. Any method, therefore, of developing deep heat in the body tissues has been accepted as an aid to the science of medicine.

Let us discuss some of the principles involved in the older forms of diathermy equipment as compared with the apparatus in use so prevalently today.

The high-frequency currents used in the earlier machines took the path of least resistance between the 2 electrodes which were applied to the area to be treated. The current displayed a tendency to circumvent hones and tendons; that is, matter and tissues of a high resistance. They followed instead the less resistant tissues, such as the lymph and blood vessels, and certain muscles.

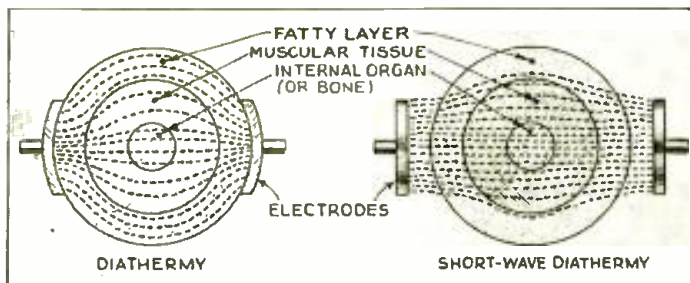

Fig. B. Comparison of path of old and new (short-wave) diathermy.

*TABLE I

SOME OF THE CONDITIONS IN WHICH TREATMENT BY SHORT-WAVE DIATHERMY IS INDICATED

- Neuritis (Nerve inflammation.)
- Neuralgia (Nerve pain.)
- Myalgia (Muscle soreness.)
- Chronic "rheumatism"
- Arthritis (Joint infections.)
- Pelvic inflammations (Such as gonorrhea, etc.)
- Nasal sinus infections
- Chorea (St. Vitus dance.)
- Syphilis of central nervous system
- Iritis (Inflammation of the iris of the eye.)
- Sciatica

**Note that although a patient's condition might indicate short-wave treatment, as per Table I, the results are not always positive; particularly insofar as complete cure is concerned. On the other hand a great deal of successful work is being done today in practically every hospital in the world; they all have their physiotherapy departments.*

L. C. B.

TABLE II

MAJOR USES OF THE SHORT-WAVE DIATHERMY MACHINE

- Short-wave diathermy (Deep heat.)
- Radio knife (Cutting with a minimum of bleeding.)
- Coagulation (Blood clotting.)
- Desiccation (Drying-up of growths, such as fungating tumors.)
- Cautery

The heat's principal concentration was found in the skin and subcutaneous layers (highly resistive tissues) in proximity to each electrode. Such heat distribution naturally reduced the efficacy

of former diathermy in the treatment of conditions affecting the deeper tissues.

The greatest oscillation rate (number of complete cycles of change from one polarity to the opposite, and, back to the original polarity) of current in these machines was approximately 2,000,000 cycles per second—or relatively long waves. The spark would sometimes jump between the skin and the electrode, with a resultant severe burn due to excessive local heat, unless the electrodes were most painstakingly applied and adjusted. The machines were usually of the sparkcoil type.

With all these shortcomings in mind, exhaustive research was made for a current with a greater power of penetration. A current that could heat with greater intensity the deep tissues, and yet not unduly heat the skin surface at the point of application. Tireless efforts were finally rewarded; for with the use of the vacuum-tube oscillator, and other new developments in the field of electro-therapeutic research, a method has been found that can produce a highly efficient current which induces a deep-tissue heat.

SHORT-WAVE DIATHERMY

The penetrative power and high efficiency of this new type of diathermy current is due to the rapidity of its oscillation, about 20,000,000 cycles per second, and the shortening of its wavelength to anywhere from 25 to 3 meters. At these frequencies the tissues show a relatively negligible resistance to the current.

The sketch in Fig. B shows the path taken by the current in the former (diathermy) types of machines as compared with the new (short-wave) types. (Continued on page 423)

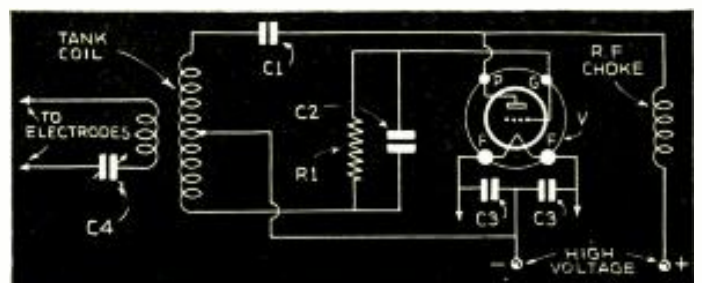

Fig. I. The circuit of a typical diathermy oscillator unit.

LOOKING AHEAD IN THE RADIO FIELD

Continuing the abstract of FCC open-forum reports the author, in this Part, discloses interesting plans in the short-wave field; and presents the newest P.A. tabulation.

R. D. WASHBURNE

PART III

PHILO T. FARNSWORTH exhibited more optimism concerning the possibilities for commercial television at an early date, than did most of the other authorities on the subject who testified before the FCC. He divulged that his laboratory was working toward the production of multipactor-type tubes capable of amplification and circuit oscillation at frequencies of 500 megacycles and higher, and delivering ½-kw. of usable output power, for use in economical 1-kw. transmitters operating in the frequency range of 100 to 500 megacycles (roughly, in the 1-meter region). (Thus what was originally a television development turns out to be a device that may open up new frontiers of scientific achievement.) As to the cost of television transmitters, Farnsworth Television Corp. have had manufactured by one of their licensees a complete television transmitting station that cost but a *small fraction* of any of the figures which have been so widely publicized! And cost estimated for television receivers "are entirely too high." Said this television pioneer, "We believe that amateurs can and should be permitted to share in the development of television by building their own television receivers." An odd quirk in the merchandising of television equipment is forecast by Mr. Farnsworth, to wit: ". . . once experimental stations are operating on regular schedules, uncontrolled manufacturers will produce television sets for public consumption even though of an inferior quality. Does anyone suppose that the Cortlandt St. gentry will not find a way to offer cheap television receivers of the bootleg variety just as soon as experimental broadcasting is regularly on the air?" Receiver manufacturers and broadcasters thus "may be forced to start television sooner than they expect."

* * *

"Modern youth, unlike Alexander the Great, need not despair for fear that the days of great exploits are over. There are many new worlds for science to conquer. . . . Of the laws that govern electromagnetic waves we know little The short wave only slowly yields its potentialities. Far from being at the end, mankind is only at the beginning of the age of miracles." This is an opinion by David Sarnoff, President of RCA, writing in a recent issue of Liberty magazine. In this article, "Why Television is Being Held Back," Mr. Sarnoff made the following comment, that visualizes the commercial possibilities of an expansive future television system, that every radio man should memorize: "To cover 3,000,000 square miles, the area of the United States, requires a multitude of television stations and presents formidable technical problems. Enormous new wire systems or radio relays must be developed to extend the television reception area from local to national service."

* * *

"Radio reporters" were envisioned by J. C. McNary, representing Hearst Radio, Inc., who pointed out that ultra-high frequencies may soon be requested for a new service—that of press pick-up for 2-way transmission of voice or printed messages between the roving reporter and the city desk of the newspaper, or the news editor of the broadcasting station, promising results already having been secured by Hearst Radio on 41 megacycles. The FCC was urged to provide for multiple channels in metropolitan areas to allow for competitive operations, in a service that would in many respects parallel those of the police service 2-way
(Continued on page 429)



Made specially for *Radio-Craft*, this illustration shows a new and novel "mobile P.A. rostrum" in the Times Square area of New York City. According to Capt. Lyell Rader, of The Salvation Army, adequate coverage is secured by means of 2 reproducers driven by two 42s, in class B; a pickup feeds one grid of a 6A6, while a mike, through a 6C6, feeds the other grid; an intermediate stage utilizes a 42 in class A. The entire outfit, of which many more are planned, operates from a 6-volt storage battery. The equipment may be removed from the dais and canopy, and set-up in an automobile, etc.

*PUBLIC ADDRESS APPLICATIONS

AIRPORTS, RAILROAD STATIONS, BUS TERMINALS—For announcement of arrival and departures, special announcements, call systems, etc.

AMUSEMENT PARKS, BASEBALL PARKS, BAND STANDS, FOOTBALL FIELDS, STADIUMS, RACE TRACKS, ETC.—For announcements, speeches, music systems, control and handling of crowds, etc. Besides voice and music amplification a P.A. system permits picking up activities at any point. Individuals can talk from any point without necessity of moving, speech can be made with a musical background, and with aid of phonograph music can be provided, etc.

AUDITORIUMS, SPORTS ARENAS, SKATING RINKS, BALLROOMS, LODGES, COMMERCIAL CLUBS, CONVENTION HALLS, ETC.—For announcements, scoring, call system, paging, music entertainment, rebroadcasting, besides use in a main auditorium to carry to adjoining rooms, entrance ballyhoo, car calling, etc.

CEMETERIES—For supplying or amplifying music in grounds, for supplying chimes from recordings, for cemetery chapel services, for portable use on various occasions.

CHURCHES—for public address in main room and adjoining rooms, for supplying chimes in lieu of bells, for recording sermons, events, etc., for music rebroadcasts, etc.

EXHIBITIONS, CARNIVALS, FAIRS, SIDE SHOWS, CIRCUSES, TENT SHOWS, ETC.—For general announcement and ballyhoo at entrance and in grounds, for supplying music, judging events, portable systems for side shows, music system for special acts, etc.

RESTAURANTS, ROAD HOUSES, BARBECUE STANDS, COOK HOUSES, CONCESSIONAIRES, ETC.—For music, announcements, ballyhoo, calling orders, instructions, etc.

FACTORIES, DEPARTMENT STORES, BROKERAGE OFFICES, LARGE BUSINESS OFFICES, ETC.—General announcements, paging, rebroadcasts, call system, etc.

HOTELS—For radio entertainment in guest rooms, amplification in main rooms, music in dining rooms, paging for use of speakers at conventions, etc.

HOSPITALS—Radio entertainment for patients, paging system, radio music for nurses' home, amplification at instruction classes, etc.

SCHOOLS, COLLEGES, ETC.—Centralized radio, rebroadcasts, for auditorium use, for individual classroom, for central talking to any one or all rooms, for principal to listen to activities in any room, music, recordings, etc.

SHIPS—Centralized radio for passengers, paging system, general announcements, for amplifying music, for general entertainment—also requirements of Department of Commerce for purpose of safety on ships of certain size and purpose; and for making hurricane warning announcements from boats or airplanes.

GARAGES—To call car wanted and thus speed up delivery of parked cars, calling for information on repairs, paging, etc.

MISCELLANEOUS—Also in: Apartment Houses; Armories; Assembly Halls; Auction Rooms; Ballrooms; Clubs; Court Rooms; Dining Rooms; Docks and Wharves; Night Clubs; Office Buildings; Roof Gardens; Sound Trucks; Swimming Pools; Gymnasiums; Trailers; Vaudeville; and Window Demonstrations.

*This listing, prepared by The Webster Co., brings *Radio-Craft* readers up-to-date on applications of P.A. equipment of every type.

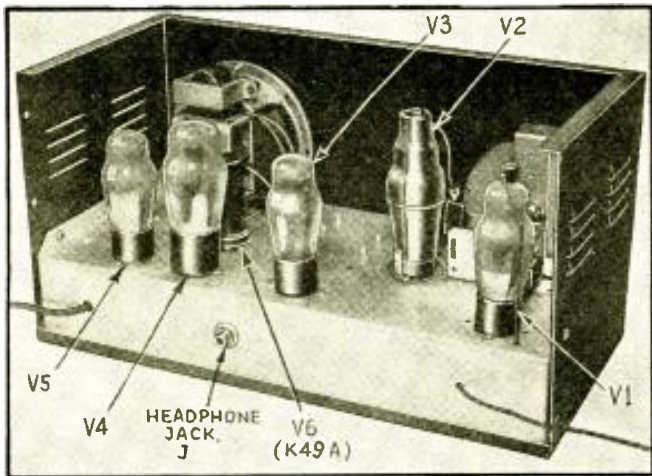

BUILD THIS 12- TO 500-METER "BANDSWITCH 5"

An easily-built, yet efficient all-wave receiver which can be assembled by almost anyone.

GUY STOKELY

The interior of the set showing positions of the tubes and other parts.

of the first 6D6 tube and given a considerable increase in strength due to the high amplification properties of this tube. Bias for this stage is furnished by the resistor-capacity combination R2-C2, the suppressor-grid and cathode being tied together. The output of the R.F. stage is electromagnetically
(Continued on page 428)

THIS RECEIVER has been designed to meet the requirements of the short-wave "fan" who wishes a sensitive and highly efficient bandswitch receiver. Covering the entire wavelength range of 12 to 550 meters in 5 bands *with no skip*, this type of instrument does away with the necessity of continually changing plug-in coils each time the listener wishes to listen on a different wavelength.

Operating from the owner's 105 to 130 V. A.C. or D.C. house lighting system and containing a high-fidelity dynamic loudspeaker and automatic headphone jack, this unit is completely self-contained and very compact. The usual

bothersome antenna trimmer adjustment has been successfully eliminated in its design. The regeneration and bandspread controls are extremely smooth in operation and even the beginner may obtain excellent results from the completed set.

Examination of the circuit diagram reveals the use of the latest in high-gain vacuum tubes; i.e., 6D6, 6D6, 76, 43, 25Z5 and K42A, functioning as a periodic R.F. amplifier, electron-coupled screen-grid regenerative detector, powerful 2-stage A.F. amplifier with pentode output stage, rectifier and complete built-in power supply.

Signals are fed into the control-grid

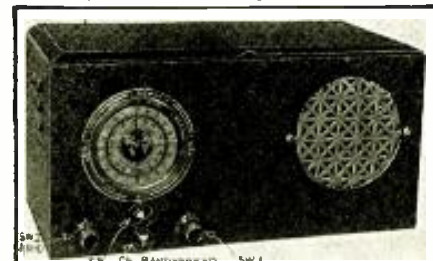

The front appearance of the set in its cabinet.

UNCLE SAM'S WAR AGAINST "BOOTLEG" S.-W. TRANSMITTERS

JOHN B. REYNOLDS

THE FEDERAL Communications Commission has from time to time received complaints to the effect that a number of so-called "transceivers" and other types of low-power transmitters sold by radio dealers are being operated as unlicensed radio stations. These stations are in use in all sections of the country and are often operated in the amateur bands, the nature of the transmissions usually being of the type carried on by amateurs.

Such operation challenges the Commission's authority to regulate radio communications, and serious interference has resulted to the television, amateur and commercial service bands.

The Communications Act of 1934, confers upon the Commission, under the provisions of Sections 2(a) and 301, authority to regulate all interstate and foreign transmissions of energy and communications by radio which originate and/or are received within the territorial limits of the United States. Accordingly, all persons who are engaged in the operation of apparatus which is used for the transmission of energy, communications or signals by radio, regardless of location, frequency or power used, are required to obtain from this Commission a permit and license to authorize construction and operation thereof.

Questions have arisen in the past as to whether or not this Commission may exercise jurisdiction over radio stations of low power, the transmissions of which are intended to be received wholly within a given state. However, this

Laws have been provided for the orderly operation of radio transmitters. These regulations with respect to stations transmitting on ultra-short wavelengths are of exceptional importance due to the popular acceptance of "transceivers."

question has been adjudicated. The courts, without exception, have held that the radio signal is interstate in character and that the provisions of the Communications Act of 1934 apply to all stations which produce radio emissions intended for reception. (See *U.S. v. Allison*, Equity No. 780, in the U. S. District Court for the Northern Division of Texas (November 1933); *Radio Commission v. Nelson Brothers Bond and Mortgage Company*, 289 U. S. 266; *Whitehurst v. Grimes*, 21 Fed. (2) 787).

In the field of engineering it is an established fact that in any use of radio the signals will at times have effects which extend beyond the borders of a state and/or interfere with transmission to or reception from other states; and the question of the Commission's jurisdiction over the operation of such stations is too well settled to any longer admit of doubt or leave room for serious question in any judicial proceeding.

Sections 501 and 502 of the Communications Act of 1934 provide penalties for the operation of unlicensed radio stations and are quoted as follows.

"Section 501. Any person who willfully and knowingly does or causes or suffers to be done any act, matter, or thing, in this Act prohibited or declared to be unlawful, or who willfully and knowingly omits or fails to do any act, matter, or thing in this Act required to be done, or willfully and knowingly causes or suffers such omission or failure, shall, upon conviction thereof, be punished for such offense, for which no penalty (other than a forfeiture) is provided herein, by a fine of not more than

(Continued on page 422)

MAKING A RADIO-CONTROLLED MODEL "SARATOGA"

Completion of design details for making a radio-controlled boat—the receiver and selector mechanism are discussed.

GEORGE C. FITZGERRELL

PART II

IN the previous installment of this article, the principles involved in effective remote radio control of a model were explained, with constructional details for a transmitter, operating on about 160 meters, and for selective relays responsive to various signals.

In the method employed, for the sake of simplicity, it is necessary that slow-acting relays be used; so that the receiving apparatus on the model boat will await the completion of the signal, before obeying it. For military and naval purposes, more expensive equipment is utilized; but this is adapted to the experimenter's home use.

To make the response more certain, both receiver and transmitter were equipped with crystal-control oscillators, which should be within 2 kc. or, preferably, 1 kc. of each other in fundamental frequency. These crystals are best obtained from the manufacturer under suitable specifications. By this means, as explained, a suitable difference-frequency, in the audio range, is produced between the radiated signal, as picked-up at the receiver, and the local oscillator; and this note is fed through the audio amplifier at the receiver, and through a rectifier into the relay mechanism, as explained below.

Each impulse so received by the relay operates a magnet and, through a pawl and ratchet, moves the selector switch one notch. Six impulses, thus, will move the wiper contact to point 6, and close its circuit. The slow action prevents the operation of the motor so controlled until enough time has passed to make it certain that the switch point chosen is that intended by the operator with his signal. Such a relay, of course, should break only a light current. A similar method is used to give automatic "SOS" signals which will ring an alarm on a distant ship at sea, etc.

THE RECEIVER

The R.F. amplifier stage, detector, and 1st-audio stage of the *Saratoga's* receiver were provided by a short-wave set of standard make. Of course the reader may use any similar receiver for this purpose equally well. Note, however, that a regenerative-type receiver is particularly desirable. The ordinary super-regenerative receiver or any other type that generates more noise than the usual quiet hiss associated with the regenerative receiver will not do.

Figure 1G (in Part I) depicts the oscillator and A.F. rectifier, and their connections to the short-wave set. (The types 58-5N-56 tubes regularly used in this receiver were replaced by their D.C. equivalents—6D6, 6D6, 76—so the receiver

filaments could be operated directly from a storage battery. The plate voltage for the receiver is supplied from a 200-V. dynamotor working from the same storage battery that supplies the receiver filaments.)

Figure 2A shows the layout of the box used to build the oscillator and A.F. rectifier. After removing the dial and other controls, the box may be fastened in place by drilling 4 holes in the chassis opposite similar holes in the metal box and bolting it in place. Wires leading to the unit are run from the short-wave set through the slot where the volume control protruded. With the box mounted on the front panel the controls must necessarily protrude into the box but the difficulties of tuning are more than compensated for by the protection that the box gives the controls from accidental detuning when all receiver adjustments are completed.

The oscillator should give little trouble. It is tuned to resonance with a pick-up coil in the same manner as the oscillator in the transmitter. The chances are that there will be sufficient coupling between oscillator and detector through the wiring of the receiver. If the reader desires to experiment with additional coupling he might try wrapping a few turns of an insulated wire around the plate lead of the oscillator and the grid lead of the detector as shown in Fig. 1G.

BIASING FOR RELAY OPERATION

A relay will not work in the plate circuit of a properly-adjusted class A audio amplifier; hence the failure of many a would-be radio-control system. If a relay is to be operated in the plate circuit of a tube then the tube must be biased to cut-off—zero plate current—either by a separate "C" battery as shown in Fig. 2B, or by some method similar to that used in the *Saratoga* (Fig. 1G). The voltage needed to bias a tube to cut-off may be found by dividing the plate voltage on a tube by the amplification factor of the tube. A tube cannot be biased to cut-off with a resistor in the cathode circuit.

The final audio stage of the *Saratoga* is coupled to the receiver proper by a 10-to-1 A.F. transformer. If the reader cannot find a transformer of this ratio (I do not believe they are made any more) then use as large a ratio transformer as possible, not less than 5- or 6-to-1.

After all wiring is completed the controls must be adjusted. Turn on the receiver and adjust the oscillator. Then bring the current in the last tube to zero or almost zero by varying potentiometer P, and watching a milliammeter plugged in jack J. Next the gain control of the receiver should be increased to maximum and the regener-

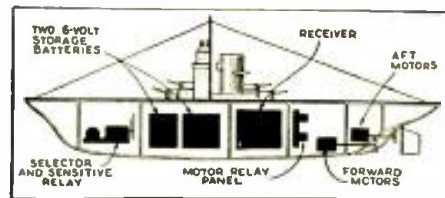

Fig. 3. Positions of the parts in the boat.

THE BOAT—THE CONTROLLED MECHANISM

The material thus far discussed (the transmitter, receiver, and selector) could readily be applied to the control of a wide range of mechanisms. The following will apply more directly to the control of model boats.

We cannot here discuss the construction of the *Saratoga* other than to say that she is a model, 9 ft. 3 ins. long and 3.25 ins. wide. Power to run the propelling motors, selector, and most of the relays comes from a storage battery. The receiver is supplied from a separate battery. Figure 3 shows the stowing of the equipment; Fig. 4 the circuit of the selector and control mechanism. The reader will note there are 4 levels of contacts on the selector and that each level controls a motor relay. The indicator light provides an orientation point for the operator in case he loses track of the number of impulses he has sent. To relocate himself he need only send impulses until the light flashes on; from which point, he knows the order of operation. The motors in the boat—there are 4 of them—perform the double duty of steering and driving the boat. To make a wide turn, the motors on one side of the boat are turned off. To make a sharp turn the motors on one side of the boat are reversed. This system gives better control than a rudder, is less apt to get out of adjustment, and is more economical of battery current since no power is consumed in a steering device. The discussion of the controlled circuits has been brief, very brief—but we felt the diagrams to be self-explanatory and of only of especial interest to the person desiring to control a model boat. The receiver, selector, and transmitter, on the other hand, will be of interest to anyone attempting a control system. Although the system is simple it is characterized by reliability—something that cannot be said of many control systems!

LIST OF PARTS

Receiver

One Hammarlund tuning condenser, 100 mmf., C1;

Two Aerovox mica condensers, .002-mf., C2, C3;

One Electrode potentiometer, 50,000 ohms, R1;

*One carbon resistor, 0.1-meg., 1 W., R2;

*One carbon resistor, 25,000 ohms, 1 W., R3;

*Two carbon resistors, 50,000 ohms, 1 W., R4, R5;

One Anillo Transformer Co. A. F. transformer, ratio 10:1 (see text), T1;

One Blau closed-circuit jack, J1;

One coil, 50 turns on tube base coil form;

One RCA type 76 tube, V1;

One RCA type 41 tube, V2;

*One crystal with monitor quartz crystal and holder (see text);

Selector and Relays

*One sensitive relay, type No. 1032, R1;

*Two intermediate relays, type No. 1251, 6 V. D.C. winding, R2, R3;

*One slow-release relay, type-series ASR (maximum release time), contact form 1B (code No. 4), coil voltage 6 V. D.C., R4;

*Two motor relays, type No. 1254, R5, R8;

*One rotary switch, No. D-87689-A, R9;

*Three paper replacement condensers for 2 mf. electrolytics, C1, C2, C3.

*Names of manufacturers will be sent upon receipt of a stamped and self-addressed envelope.

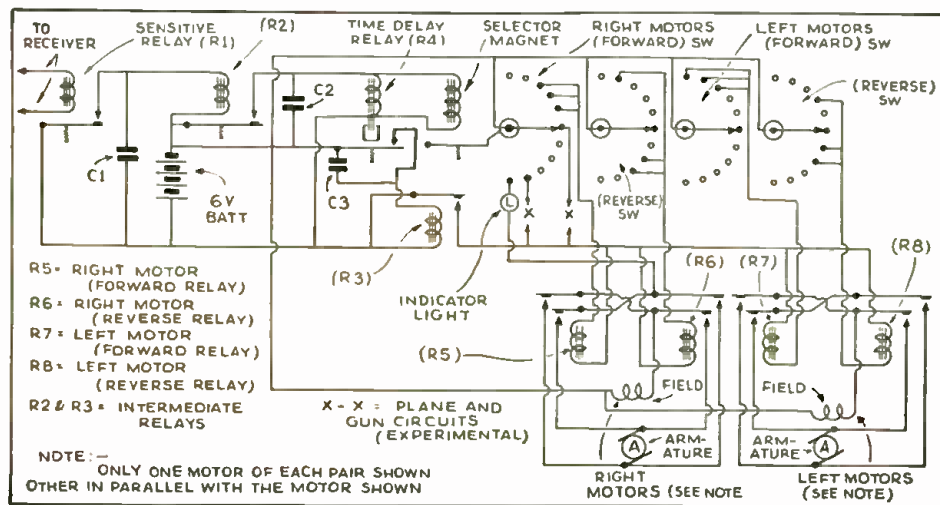
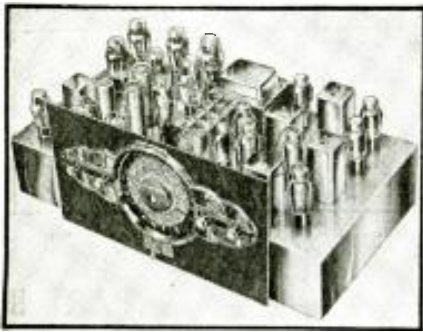

Fig. 4. Selector and control mechanism. Relay R4 contacts, incorrect in Fig. 1D, are shown correctly.



NEW "CURRENT-SAVER" CIRCUIT FOR 18-TUBE ALL-WAVE SET

One disadvantage of modern sets, using many tubes, is the current drain for low volume—a cure is described.

CHARLES SLOAN

THE LATEST THING in multi-tube all-wave receiver operation is to design the power supply for greater economy of operation. A well-known all-wave radio set manufacturer has accomplished this, in the 1937 models of their 18-tube chassis (shown in the heading illustration), by over-winding and tapping the primary of the power transformer so that when the applied voltage is effectively lowered 30 per cent, the watts input is correspondingly lowered 50 per cent without sacrificing reception of high-power signals. The circuit arrangement is here shown.

This lowering of the applied voltage is made possible by the use of the new 6-V. receiving tubes, which are primarily designed for automobile receivers and which will operate satisfactorily even though the battery may drop from the 8-V. over-charging condition to 5 V. or less when the battery is depleted. These tubes are further designed to permit a filament resistance type volume control allowing operation clear down to 3 V.

Taking full advantage of this wide range of operating voltages, switches and transformers have been developed which permit the operator to shift speed, as it were. The radio set is allowed to heat up quickly at full applied voltage and then the operator may rotate the switch to 2nd and 3rd speeds, thus operating the entire receiver at reduced voltages.

The results are surprisingly similar to those obtained at higher gear ratios in an automobile. All unnecessary noises are eliminated. The hiss, fringe noises, static crashes, over-amplification of audio noises, and, in fact, all unpleasant sounds are immediately eliminated from the loudspeaker. The set settles down to a quiet, smooth "run," and one can lean back in comfort and enjoy the most pleasing popular stations on the air. In tuning from one station to the next, all the unpleasant, weak stations are eliminated and likewise all rasping static noises.

Technicians may question the possibility of securing good tonal response but practice shows that the objection is more theoretical than real. The

tone fidelity at these reduced voltages is fully as good as that at full voltages and much more pleasing to handle between stations. This is due to lowered A.F. and R.F. gains giving lower noise levels.

THE IMPROVED-STABILITY OSCILLATOR

When this idea was first in the development stage, it was found that the oscillator ceased to function when the line voltage was reduced to an equivalent of 90 V., and became very weak at 100 V. A totally new oscillator circuit was necessary in order to overcome this difficulty. A modified form of the Colpitts' oscillator circuit was evolved, which continues to oscillate down to 30 V. applied line voltage! The result is a remarkable increase on normal voltages, on all frequencies, and, particularly the high-frequency short-wave stations.

(Continued on page 132)



The transformer taps effect the current saving by reducing tube voltage.



A department devoted to members and those interested in the Official Radio Service Men's Association. For mutual benefit, contribute *your* kinks, gossip and notes of interest to Service Men, or others interested in servicing.



The "service shop on wheels," mentioned as a possibility in the June, 1936, issue of *Radio-Craft* is a reality. This unit combines: 1—vibrator analyzer; 2—receiver servicer; 3—R.F. oscillator; 4—universal speaker; 5—"B" supply unit; 6—multi-range antenna; 7—master control switch. (Write for additional data—ask for No. 1254)

LICENSE FEE

RADIO-CRAFT, ORSMA Dept.:

In answer to Mr. Buchanan's letter, regarding a license fee for Service Men, I wish to state my views. A fee of this type would be merely an added drain on the already flat purse of the radio Service Man and would be a useless expense, accomplishing nothing.

The average Service Man is paying enough on gasoline, sales tax, etc., without yelling for more taxes and license fees! What Federal law or license law is going to keep the set-owner from calling the kid next door to bring over his screwdriver and look over his set? Said owner probably thinking he can get his set repaired for "2 bits."

Laws are one thing and enforcement is another. Who is going to the expense of beating the unlicensed Service Man and prosecuting him, and going through all the long legal procedure just for principles' sake?

I believe, and it is borne out in hundreds of cities, that if the honest-to-goodness Service Men will get together in their communities, talk things over, and organize, they will go far toward eliminating their difficulties. Yelling for laws which are practically impossible to get passed or enforced, will get them nowhere.

Last but not least, too much stress is laid upon the so-called "screwdriver" Service Man. In my experience, the majority of the work that these lads get is from customers who expect something for nothing—and I don't want this class of work.

When Mr. Buchanan attempts to formulate and have the authorities pass a License Law for radio service, he will find that he needs a wagon load of money and is up against the hardest stone wall he ever encountered.

(NO NAME)

Although the writer forgot to sign his name, we deemed his ideas of sufficient interest to the fraternity to warrant publication; although, ordinarily, we do not print letters that are unsigned, or signed only with a pseudonym.

A LOW-RANGE RESISTANCE METER

RADIO-CRAFT, ORSMA Dept.:

A low-range resistance meter of extreme accuracy is very desirable to the experimenter or Service Man. Where shunts have to be made to increase the range of milliammeters, etc., the instrument about to be described will prove very useful.

A study of the schematic, Fig. 1, will show that the principle used is the well-known shunt type of resistance meter. However in the usual arrangement the value of R is determined by the meter reading. It is well known that as the pointer of the meter approaches either maximum or minimum reading the accuracy falls off owing to the large range covered at these positions. The writer came to the conclusion that greater ac-

(Continued on page 435)

EXPERIMENTS WITH A "HI-FI" AMPLIFIER

Part I, last month, included a description of this reasonably-priced, high-quality amplifier; and suggested several possible applications. Part II, here, describes the methods of using the amplifier to best advantage.

ARTHUR H. LYNCH PART II

If we happen to live within 10 or 15 miles of a powerful broadcasting station very satisfactory results may be obtained by applying the circuit which is shown in Fig. 2D. This circuit is very easily assembled by utilizing one of the old 3-circuit tuners, designed for use in connection with the regenerative type of receiver which was so popular many years ago. It will be observed that the normal primary of such a 3-circuit unit is not used and the coil which was normally provided for use as a tickler is now employed as an untuned antenna circuit. The rotation of this coil makes it possible for us to secure a desirable degree of coupling between the antenna circuit and the secondary tuning circuit which feeds directly into the amplifier itself. (It should be borne in mind that the 500-mmf. fixed condenser which is shown between the lower end of the circuit and the ground is absolutely essential. If it is not used the resistor, R3, will be shorted and the push-pull character of the amplifier will be eliminated, as outlined previously.)

It should be remembered that high-fidelity reproduction presupposes an absence of interference. If a broadcasting station is not sufficiently near to permit our hearing it without the disturbances which are caused by either natural or man-made static and if one of the so-called "tone controls" is necessary to cut out this type of noise, high-fidelity reproduction no longer exists.

On the whole, we are of the opinion that this type of amplifier finds its greatest application and produces the greatest satisfaction when it is used in conjunction with modern, high-fidelity phonograph records and a good electrical pickup. The use of a crystal pickup has been found very satisfactory as well as very simple and the arrangement for employing it is shown diagrammatically in Fig. 2E.

If, on the other hand, a magnetic type of pickup is to be employed, an impedance-matching transformer with a primary impedance matching the output impedance of the pickup, and a very high secondary impedance so as to approximate a match when the input of the amplifier is used in the manner illustrated in Fig. 2F, should be used.

If the amplifier is to be used for public address work, in conjunction with the making of announcements, etc., the arrangement shown in Fig. 2F will do very well if a high-gain, single-tube carbon microphone is employed. In such arrangements the microphone and microphone battery are placed in series with the primary of the transformer.

If a crystal microphone is used it will be neces-

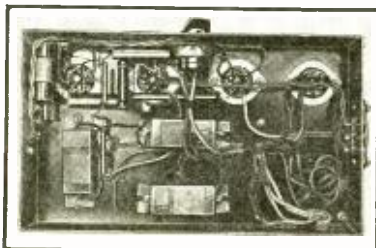

Fig. B. The underside of the amplifier chassis. Note the simple, neat layout of parts.

sary to employ a preamplifier between the crystal microphone and the input to the Kathodyne amplifier. The same precaution regarding the short-circuiting of resistor R3 is necessary.

If reasonable care is employed in the selection of the parts it is unlikely that any difficulty will be experienced in the building of this unit. It is not desirable to substitute other units for those which have been used, unless you are positive that they will provide the same electrical characteristics. Attempting to build this amplifier with inferior parts will lead to nothing but dissatisfaction.

There are but a few important points which need to be checked in order to be sure that the amplifier is functioning satisfactorily. The resistors, R4, should be checked so as to be sure that there is no voltage across them. The 50,000-ohm resistor R5 should show a reading of approximately 60V. when the voltage supplied by the power unit is 250 V. at 150 ma. The 0.1-mcf. resistors indicated by R3 should be absolutely alike so as to provide suitable balance. It is recommended that a very good resistance and voltage meter be used in making these checks.

An alternative method for operating 4 speakers, having individual volume controls, is shown in Fig. 2G. For clarity, we have eliminated the portion of the diagram covering the apparatus for exciting the speaker fields. With the arrangement shown here, separate excitation of each field is required.

USING 2 REPRODUCERS

By far the simplest method for securing real fidelity from this amplifier at the least expense may be had by using a pair of the specified-type speakers, with their voice coils in series, as shown in Fig. 2B. The impedance of the voice coil in each of these 12-in. permanent-magnet reproducers is approximately 6 ohms. If the speakers are placed some 10 or 12 ft. apart and a low-resistance twin conductor is used to join them, the overall impedance will be approximately 15 ohms. This is a perfect impedance match for the 15-ohm winding on the specified output transformer which has been designed for coupling a pair of 6L6 tubes to various types of speaker loads.

In our own application of this amplifier we have found the use of the permanent-magnet type of reproducer to be ideal. It eliminates the necessity of providing a local rectifier and filter circuit for supplying the field current for the electrodynamic type of reproducer. In many instances, in the past, this type of unit has caused trouble as a result of failure to switch off the field supply when the speaker was not in use.

The arrangement that we use suffers from one disadvantage. The volume control on the amplifier controls the volume of both reproducers simultaneously. However, since both speakers have a power handling capacity of 8 W., it is possible for us to realize the full gain of the amplifier. More elaborate circuits will suggest themselves to the experienced operator of high-fidelity amplifiers when it is desired to use a greater number of speakers.

Possibly the best arrangement where 4 speakers are to be used will be found in Fig. 2C. Here we have what is known as a series-parallel arrangement and the 500-ohm output winding of the transformer is coupled, by lines of any desired length, to the various loudspeakers.

In this instance each reproducer is provided with a suitable 500-ohm input and individual

(Continued on page 442)

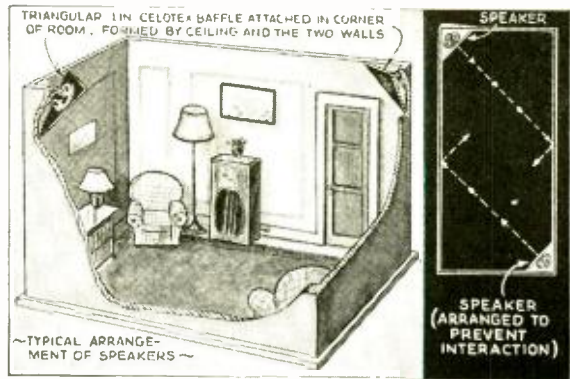

Fig. B. The mounting of the speakers is of utmost importance in preventing interaction between the pressure areas created by the individual units, yet having them placed so that they project sound at "ear level". Otherwise, the high frequencies, which are projected in a beam in front of the speaker cone, are not heard.

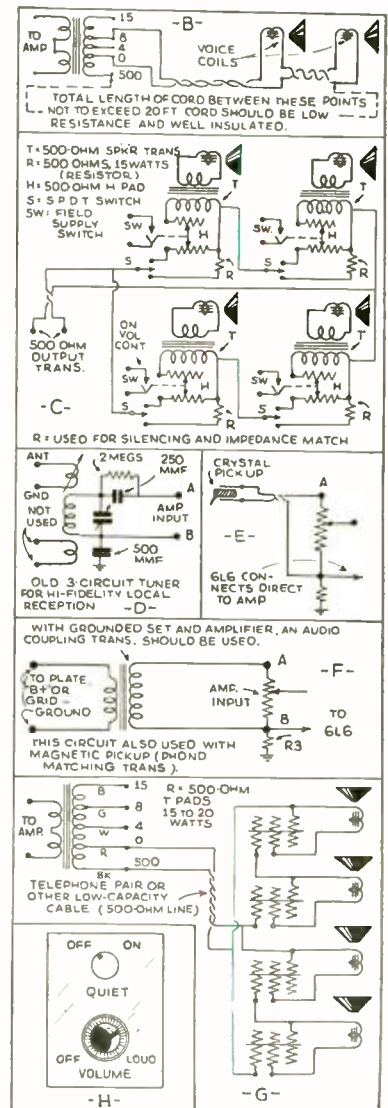

Fig. 2. Details B to H are repeated here to eliminate the necessity of referring to Part I.

BUILD THIS BEAT OSCILLATOR FOR DX RECEPTION AND CODE

DX stations can be tuned-in easier with a beat oscillator, which brings them in with a whistle! This is an item for the experimenter.

C. P. MASON

DESIGNED to enable the short-wave enthusiast to receive, with his standard all-wave set, the interesting code signals which are so numerous, this beat-oscillator unit will assist also in locating weak DX broadcast and S.-W. stations; because it will bring out the carrier wave strongly as an audio whistle, and thus afford apparent sharper tuning.

OBTAINING THE BEAT NOTE

Radio, as a means of point-to-point communication, depends on the production of a carrier wave which is interrupted at intervals to give a tone; but may be used to produce a steady note by "beating" it, with a locally-generated frequency, to produce an audible heterodyne or whistle. With the old-fashioned regenerative sets, such reception was

easy to obtain by tuning the detector, in a state of oscillation, a kilocycle (1,000 cycles) or less off the received C.W. (continuous-wave) signal.

This new unit, designed for attachment to later sets, performs the same purpose when connected ahead of the 2nd-detector of any modern superheterodyne. The connections are as simple as those of the older converters or "signal boosters": the adapter used is plugged into the socket of a 6F6 output pentode, to draw current for energizing a 6C5 tube used as a triode. The parts shown can be mounted in, and shielded by, a metal chassis only 4 3/8 x 3 x 1 in. high; the gridleak and condenser, mounted on the coil, are covered by its shield. The shielded coupling lead is bared for about 1 1/2 ins. at the end so

(Continued on page 432)

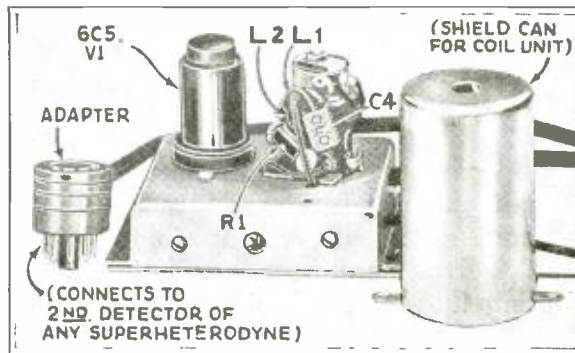

Fig. A. The chassis of the I.F. beat oscillator.

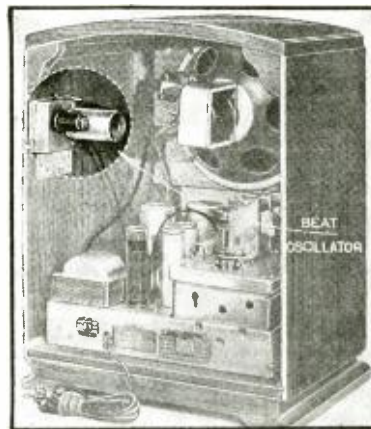

Fig. B. The unit installed in a G.E. set.

BASIC OSCILLATOR CIRCUITS YOU SHOULD KNOW

ALFRED A. GHIRARDI

OF THE refinements which have been made in the art of servicing in the past 10 years, the most important are due, undoubtedly, to the introduction of the portable oscillator and the oscilloscope. It will be of interest, we feel sure, to many—Service Men, and others—to recapitulate a few facts about the former. These same fundamentals apply, within certain limits, to the use of these circuits as oscillators in a radio receiver ("superhet").

In the old days, after a set had been wired together, and checked to see that the "B" battery had not been shorted

across the filament, the next step was to turn the switch and tune-in a broadcast station. Adjustments were then made for maximum strength of reception, and—if there were two or more tuned R.F. circuits—this was the method of matching them; but, with modern receivers, this method is inadequate. The tuned and calibrated "service oscillator" now takes the place of many stations, on all wavebands; and, in addition, furnishes a method of testing the I.F. and the A.F. amplifiers, as well as the R.F. end.

(Continued on page 443)

Every radio man should be familiar with oscillators and modulators—the very bases of radio communication.

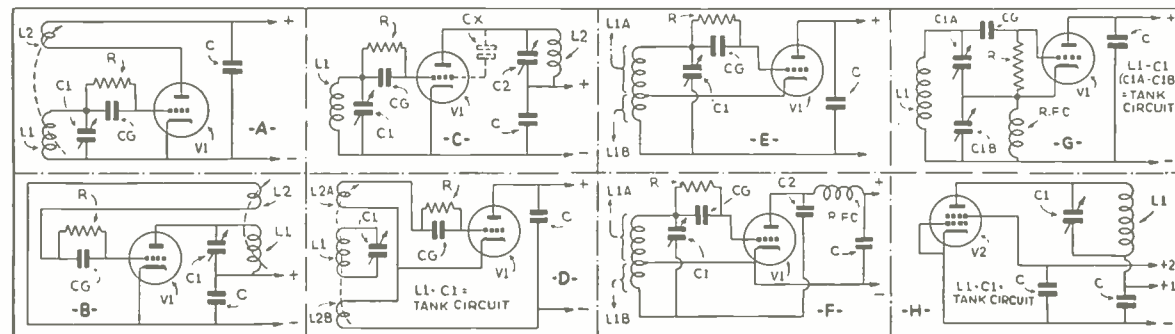

Fig. 1. Circuit types: A, tickler feedback—self-modulated; B, reversed feedback; C, tuned-grid, tuned-plate ("T.G.T.P."); D, Meissner; E, Hartley—series-feed; F, Hartley—parallel-feed; G, Colpitts; H, dynatron.

AWARDS IN THE CONTEST
FIRST PRIZE \$10.00
SECOND PRIZE 5.00
THIRD PRIZE 5.00
 Honorable Mention

USEFUL CIRCUIT IDEAS

Experimenters: Here is your Opportunity to win a prize for your pet circuit idea, if it is new, novel, and useful.

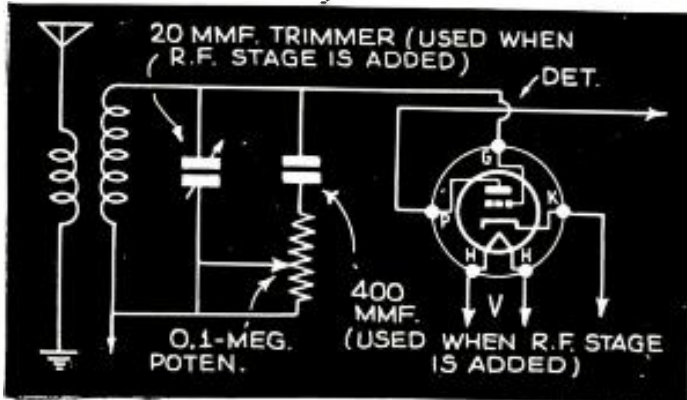

Fig. 1. A tuning system for midget set.

FIRST PRIZE—\$10.00

"RESISTANCE TUNING." The method shown in Fig. 1 eliminates the necessity of large, expensive ganged condensers for tuning, in pocket or other small sets, the writer has discovered. A fixed condenser of, say, 400 mmf., is shunted across the tuning coil, in series with a 0.1-meg. potentiometer, which is varied to alter the response of the circuit. When 2 stages are used, a small, trimmer-type condenser may be used to bring the R.F. circuit into line with that of the detector. (It is one form of the "resistance tuning" system now utilized in many A.F.C. or automatic frequency control circuits.—*Editor*)

ROBERT H. PAASCH

SECOND PRIZE—\$5.00

TIME-DELAY CIRCUIT. Many experimenters want a means of delaying the closing of a circuit by an accurately predetermined length of time; this would be useful in the construction of robots, selector systems, burglar alarms, etc. The following description of one may prove useful. (See Fig. 2.) Unit L1-L2 is a 2-coil relay; L1 has a high impedance, to match the input signal, and L2, which is wound over L1, a low impedance. The signal applied to L1 closes switch S1 and completes the secondary circuit of the filament transformer T, which includes L2. The coil L2 holds the circuit closed until the cathode becomes heated and current flows through L3; this closes switch S2 and, a fraction of a second, later opens S3 and cuts off the current from L2; this releases S1 and the circuit is again ready for

operation, as soon as the cathode has cooled.

By using the older, type 27 tube and normal filament voltage, about 30 sec. is required to close S2. However, by using a transformer, T, with a 5-V. secondary, and a rheostat, R, of about 7 ohms, the time may be adjusted from 10 to 60 seconds. By using a filament-type tube, this time may be greatly decreased.

Details for relays L1-L2 and L3, are not given; as most experimenters have relays on hand or know how to build them. Note that L2 must have a low resistance. The arm of S2 should be about one-half the length and weight of that of S3, so that it will close sooner and have time to operate the output relay (not shown).

Notice that S2 is closed only momentarily, so that another relay must be added to keep the circuit closed; also that only a momentary signal need be applied to L1. However, by changing the transformer connection, from X—Y to X—Z, S2 will remain closed as long as the signal is applied to L1.

JOSEPH ELIE TEMPLER,
Chilliwack, B.C.

THIRD PRIZE—\$5.00

AN IMPROVED DIODE DETECTION circuit that also provides interstation noise suppression. I have tried out many of the circuits you have presented from time to time for modernizing old receivers. The diode detectors (55, 2A6, 2B7) have helped very much, and make it easy to add automatic volume control; but they have two main faults—attenuation of low frequencies, and poor quality at low volume.

The circuit I submit (Fig. 3)

overcomes these faults, and provides additional suppression of noise between stations. I have found the 2B7, with screen-grid tied to plate, superior to the other two. None of them are good amplifiers when the bias becomes less than 1V. By increasing self-bias (R1-C1 in diagram) another volt, this fault is overcome. As they will not detect or amplify signals below 1V., the ordinary noise is suppressed; though without loss of sensitivity, as lower signals would not be heard above the noise level.

Attenuation of low notes at low volume is caused by the low impedance in the control-grid circuit of the amplifier section of the tube. This is overcome, in the better modern receivers, by the use of an "L" pad as volume control; but it is done with less trouble and expense, almost as well, by putting the .01-meg. resistor (R2 in diagram) between the control-grid and the arm of the volume control. The lead to the control-grid cap should be shielded, and shield grounded; this will also bypass high frequencies that may get through.

THOMAS H. JASPER

HONORABLE MENTION

AN OSCILLATOR FOR TESTING LOUDSPEAKERS. The cost of an A.F. oscillator, for checking speaker rattles, is saved by this method, applied to a superheterodyne with a service R.F. oscillator, which is cut into the cathode-return of the 1st I.F. tube, as shown in Fig. 4. The oscillator is tuned to approximately the I.F., and then varied to give a beat note of any desired pitch. For instance, if the I.F. is 175 kc., the service oscillator at 174 kc. will give a 1,000-cycle audio note. The I.F. transformers should first be lined up.

CHARLES FORSCH

HONORABLE MENTION

"TUNING EYE" CONDENSER TEST. The indicator "eye" output indicator, described in the April, 1936, issue of *Radio-Craft*, furnishes a method for making a tester for condensers of high capacity. Place the positive lead from a 45-V. battery on the central (grounded) terminal of the indicator; the condenser in series with the "Lo" terminal of the indicator and the negative lead of the battery as shown in Fig. 5. The "eye" will glow green while the condenser is charging but, if in good condition, will immediately return to normal.

GEORGE W. LEITNER

HONORABLE MENTION

OUTPUT METER FROM TESTER. The meter in your tube tester may be used as the output indicator of a set, with the simple addition of a type 5X tube. Simply place the tube in the socket, and connect to its control-grid cap the set which is to be balanced, as shown in Fig. 6. Reduce the bias, and adjust the other element controls for maximum swing. The meter, which is protected from overload, will read downwards for maximum swing.

WALTER L. SHERMAN

(Continued on page 433)

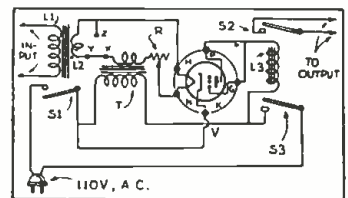

Fig. 2. A V-T. type time-delay relay circuit which is variable from 10 to 60 seconds.

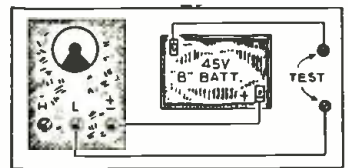

Fig. 5. Indicator "eye" tester.

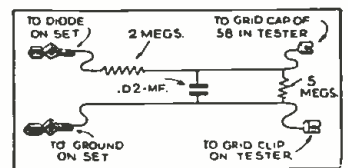

Fig. 6. Tube tester output meter.

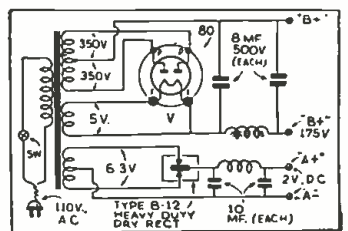

Fig. 8. Electrifying battery sets.

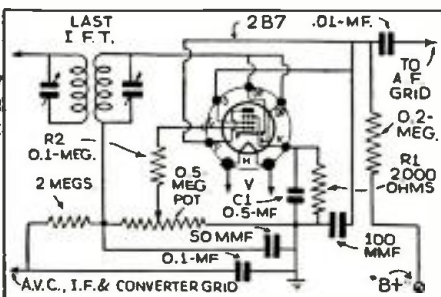

Fig. 3. Improved diode detector system.

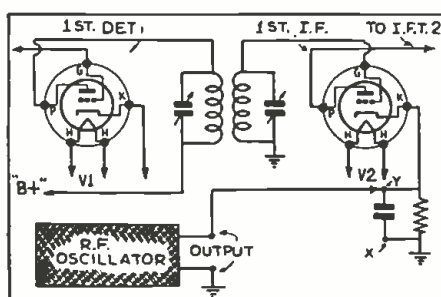

Fig. 4. "Beat" testing speakers with R.F. oscillator.

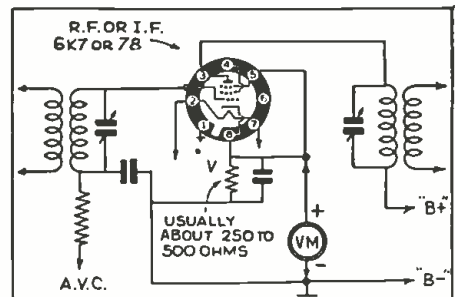
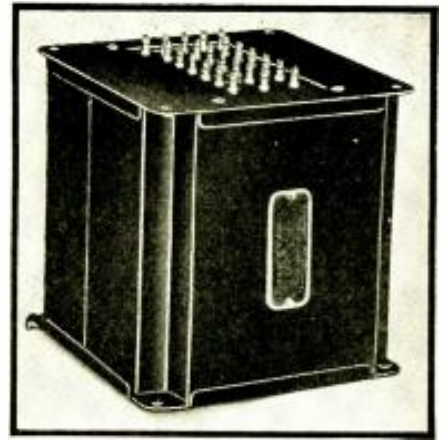

Fig. 7. Voltmeter applied as tuning meter.

A NEW TRANSFORMER DEVELOPMENT

Obsolescence in power transformers is eliminated by a novel design of transformer which has unusually wide circuit possibilities. This is especially suitable for P.A. systems.

J. B. CARTER



Extreme flexibility is assured by this unit.

PROBABLY the biggest bug-a-boo in radio is the ever-existing menace of obsolescence.

Of course in such a modern industry new developments are constantly being born, and the older methods are soon discarded to make room for the later developments. Such is the march of progress in this gigantic, far-reaching industry. However, from the experimenters' point of view, obsolescence is quite expensive especially when it involves discarding costly equipment that still functions. Whenever new tubes are announced they are no doubt vastly superior to existing types, but due to different load impedances, voltages and circuit applications present equipment cannot be utilized. In many instances the circuit changes in R.F. and A.F. circuits are inexpensive, however, a change in these circuits usually necessitates a change in the power supply. This is often the most expensive unit in the entire device regardless of the application.

A good example of this situation is found in high-power public-address systems; the low-power tubes require exceptionally good filtering to keep hum level as low as is consistent with good practice. If these low-level stages derive their voltage supply from the high-voltage system it is necessary to thoroughly filter the entire power supply, not only to eliminate hum but also to reduce feedback to a minimum. Of course, this may be eliminated by filtering a small section that supplies only the lower-level tubes. This

method however jeopardizes condensers, etc., should the load be removed from this section. Another method to eliminate this hazard is to use a separate transformer for the input or low-level stages. The drawback to this procedure is the excessive cost and is therefore not practical for economical reasons.

A prominent transformer manufacturer plans to put on the market a power transformer that forever ends the type of obsolescence mentioned above; the commercial design is shown in the heading photograph. This radically new transformer innovation permits the use of any known existing type of rectification to be used with this unit in the most practical and economical method developed to date.

In using a transformer of this type it will be apparent that variation of the primary voltage (by taps) to secure various high-voltage secondary outputs would disturb filament voltages obtained from the same transformer. Hence, a second or filament transformer with one or more filament-voltage secondaries is required with this new transformer.



CAPABILITIES OF THE NEW TRANSFORMER

The voltages available from this transformer range from 400 V. up to 3,000 V. depending upon the type of circuit used. In schematic Fig. 1 are shown 3 separate D.C. supplies (Continued on page 433)

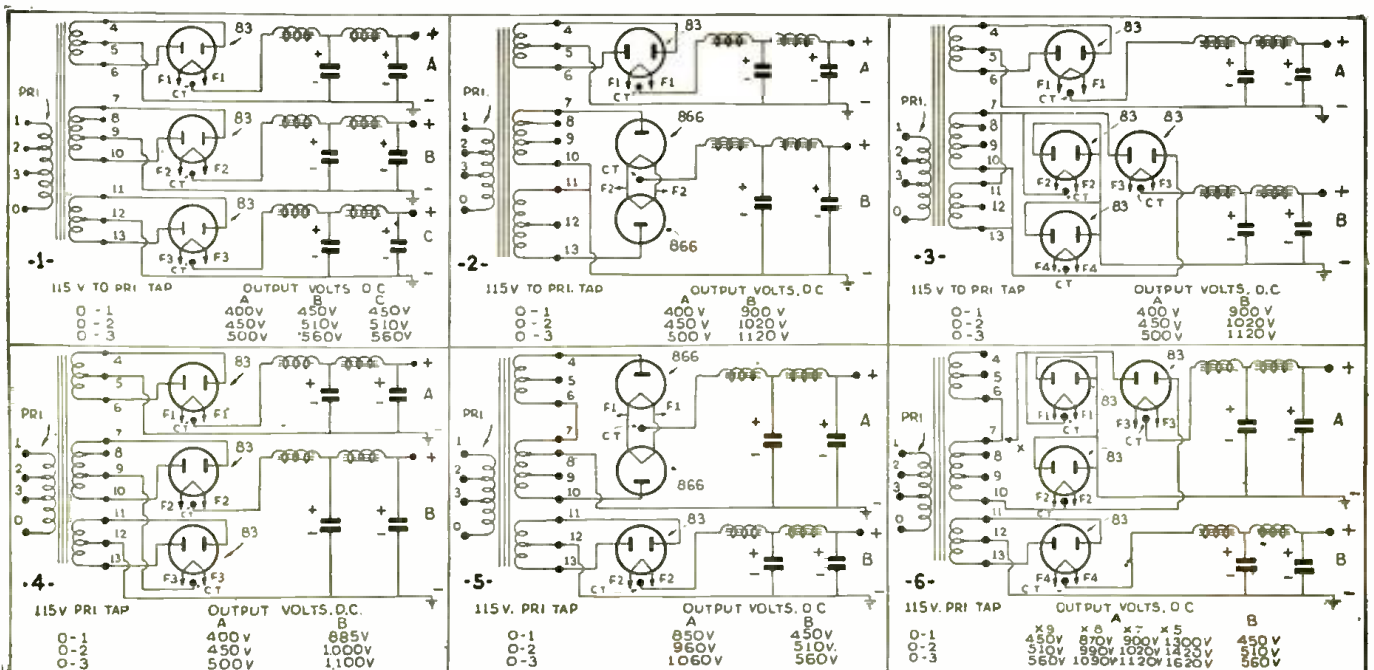

Some of the circuit combinations which are made possible by this new type of power transformer. Note the wide voltage range of the circuits.

AN EASILY-BUILT CONDENSER ANALYZER FOR THE SERVICING BEGINNER

This instrument will be found of extreme importance to the man who is breaking into servicing. It will save time!

ALFRED W. BULKLEY

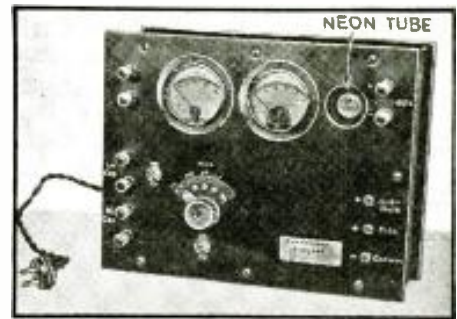

Fig. A. The front panel showing controls.

LOW COST and simplicity are the features of this Condenser Analyzer which checks any filter or bypass condenser, either paper or electrolytic type, for leakage and capacity.

The 2 meters required are of a type commonly found around many radio shops or readily available on the used-parts market. This particular instrument shown in the photo, Fig. A, was built in the case of an old W.E. type 7A amplifier, but of course any suitable cabinet may be used.

The meter used by the writer for checking capacity is described in

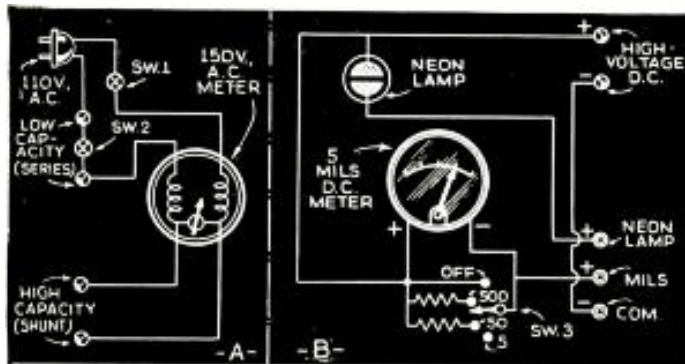

Fig. 1. The circuit diagram of the 2 parts of the unit.

the List of Parts. Closing switch 1 connects this meter to the A.C. line in series with the 2 binding posts, Fig. 1, marked Low Capacity. Switch 2 is left open. Paper condensers between the sizes of 0.01-mf. and 0.5-mf. will give readings on the meter which are referred to the calibration chart you make up from standards. Do not attempt to check electrolytic condensers on this range, as they would be damaged by the high A.C. voltage.

To prepare the meter for reading higher capacities, it is necessary to open the meter case and bring out 2 leads directly from the movement. These leads attach to the junction of the movement and the multiplier coils, of which there is one in each leg. These leads connect to the High Capacity binding posts.

To use the high-capacity range, close switches 1 and 2, then any condenser connected across the High Capacity binding posts acts as a shunt across the meter movement and causes the hand to drop back to a value which may be referred to the shunt line on the chart to determine the capacity. This range may be used to check the capacity of electrolytics, since the A.C. voltage across the meter movement is so small that it does not damage them.

(A convenient paper on which to draw the capacity chart is Keuffel & Esser No. 258-71 Semi-Logarithmic paper. On this paper the capacity "curves" are straight lines.)

The other section of the analyzer consists of a milliammeter and a neon bulb (one or two watts) connected to an external power supply, preferably one with several voltage taps such as 25 V., 50 V., 100 V., 200 V., 300 V. and 450 V.

The neon bulb checks leakage in paper condensers. Insert test prods into tip jacks marked Common and Neon Bulb and touch prods to the terminals of the condenser. A good condenser causes the bulb to flash

(Continued on page 411)

The description of the single-unit visual analyzer is concluded, with an analysis of the circuit printed last month.

GARLAND W. ARCHER

NEW DEVELOPMENTS IN CATHODE-RAY EQUIPMENT

PART II

IN ADDITION to the visual resonance functions of this instrument, there are many other uses; as, for example, in showing true adjacent-channel selectivity, R. F. signal distortion, A.F.-signal distortion, presence of regeneration, oscillation, hum, noisy circuits or tubes, condenser leakages, showing tube characteristics, static, dynamic or oscillating at desired frequency, modulation measurements, vibrator adjustments, P.A. work, speaker and microphone characteristics, filters, production testing, and a host of other uses in the laboratory, production and field, of not only the radio industry but hundreds of other industries.

In order to further extend the utility of the unit, there has been incorporated an audio oscillator of the beat-frequency type having a frequency range which is continually variable from 50 cycles to 10,000 cycles.

The variable-A.F. output is obtained from heterodyning 2 voltages of slightly different radio frequency. The output (beat) frequency is varied by changing the frequency of one of the oscillators by means of a variable condenser in its oscillating circuit. In order to prevent any tendency which the 2 oscillators might have to pull into zero beat when generating low audio frequencies, a type 6F7 tube is utilized, connected in a unique circuit (see schematic) in which the triode section serves as a buffer amplifier and the pentode section as a Hartley oscillator. The incorporation of the oscillator-buffer-amplifier combination absolutely prevents any possibility of automatic synchronization (lock-in) of the 2 oscillators.

Purity of the audio output or beat frequency is another of the design features which has been

given very careful consideration. The harmonic content of the output has been kept well within 5 per cent by utilizing an R.F. filter that discriminates between fundamental output and harmonics. The latter, if present, would give rise to spurious beats which are quite common in the majority of commercial variable audio test oscillators.

Various thermal effects have also been carefully considered, for example, the heat generated by tubes, resistors, etc., which tend to warm the 2 radio-frequency oscillators at different rates and result in slow frequency drifts that usually take hours to become stabilized. This difficulty has been eliminated by proper mechanical arrangement of the component parts.

An audio amplifier has also been incorporated which is used in conjunction with the beat-frequency oscillator for providing an output of sufficient amplitude, the response characteristics of which are approximately linear for all frequencies up to and including 10,000 cycles.

The complete beat-frequency audio oscillator of the unit may be summed up in a few words as being an audio oscillator which is of the direct-reading type continuously variable from 50 cycles to 10,000 cycles, having a constant amplitude over the entire range of frequencies, with 1 stage of A.F. amplification and a harmonic content in the output circuit which does not exceed 5 per cent.

For ordinary oscilloscopic work and proper adjustment of the unit, there has been incorporated spot adjustment controls, the function of which is to provide a means for compensation of the difference in cathode-ray tubes, that is,

(Continued on page 444)

CIRCUIT ADDENDA

(Refer to schematic circuit in Part I)

THE TUBE V1 serves 3 distinct purposes: when the function selector switch is set to the No. 1 position, the type 6F7 tube functions as a variable-frequency R.F. signal generator, the output of which is mixed in the type 6A7 for producing at the output pin jacks of the variable audio oscillator an audio-frequency potential which may be varied from 50 cycles to 10,000 cycles.

When the rotary function selector switch is set to the No. 2 position, the type 6F7 functions as a frequency-modulated oscillator which is frequency-modulated over a constant band width of 24 kc., the output of which is mixed in the 6A7 tube with the variable R.F. signal to produce at the R.F. output jacks a signal which is frequency-modulated over a constant band width and variable over a band of frequencies which lie between 125 kc. and 60 mc. (megacycles). After setting the function selector switch to the No. 3 position, the proper connections are made to the type 6F7 tube for amplitude-modulation of the R.F. output of the 6A7 variable oscillator. The frequency of the modulator stage is peaked at 400 cycles and modulates the carrier 30 per cent. The type 84 tube is used as a full-wave rectifier for supplying the D.C. potentials to the oscillator section of the diodescope. The 6A7 tube is a dual-function unit serving as a mixing tube and R.F. signal generating tube. The type 76 is used as an A.F. amplifier for variable audio output of the signal generator. The 2 type 57 tubes are used as amplifiers for the horizontal

(Continued on page 445)

THE LATEST RADIO EQUIPMENT

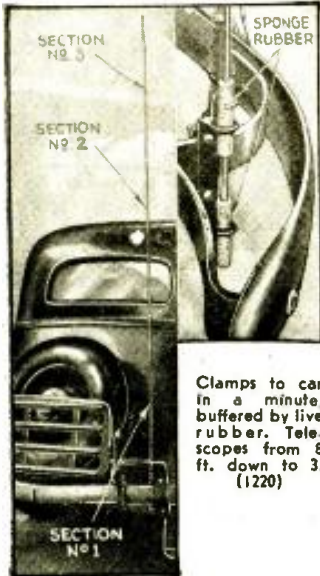

Clamps to car in a minute, buffered by live rubber. Telescopes from 8 ft. down to 3. (1220)

VERTICAL CAR AERIAL (1220)

(Tobe Deutschmann Corp.)

WITH advantages of increased pick-up or (for a transmitter) radiation, the rod-type aerial is increasing in favor with police departments, and of high military use in short-wave work. It is also more efficient for the private car owner in obtaining reception (especially, in turret-top cars), while not as subject to damage as the underslung type. The model shown (which is particularly fine for 5-meter receiver and transceiver operation) has been lately improved, being attachable instantly without drilling or tapping. The length is adjustable within the limits of 3 to 8 ft.

COMPENSATED V.-T. VOLTMETER (1221)

(Triplett Electrical Inst. Co.)

BY means of a new bridge circuit developed for this instrument, it is made accurate, regardless of changing emission characteristics of tubes used, and therefore self-calibrating. Since it draws no current from the circuit tested, it measures both A.C. and D.C. voltages with high accuracy. The tilting panel has 2 instruments: (1) galvanometer, left, showing balanced bridge; and (2) 3-range meter, right, measuring D.C. or peak A.C. up to 50 V. Size, 7 $\frac{1}{2}$ x 6 $\frac{1}{2}$ x 4 $\frac{1}{2}$ ins.; metal case.



Tube does not affect accuracy. (1221)

7-TUBE A.F. AMPLIFIER (1222)

(Radolek Co.)

THIS 4-stage amplifier, using 7 tubes (1 75, 2 6A6, 2 6B5, 1 83) has 130 db. usable gain and a 15-W. "undistorted" output; supply for 2 2,500-ohm speakers; high-gain mike channel, low-gain phono-radio, with separate volume controls; tone control, mixer and fader. The characteristic is given as flat within 2 db. from 50 to 10,000 cycles. Output impedance 15 ohms, tapped at 8.

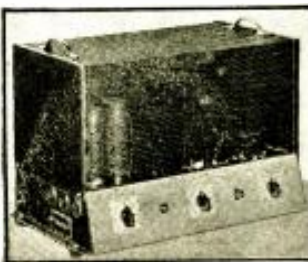

All-around P.A. amplifier (1222)

AIRPORT RECEIVER (1223)

(RCA Mfg. Co., Inc.)

SIXTEEN tubes, all-wave, "magic brain," "magic eye" tuning, interchangeable units for rack and cabinet mounting, double shielding, high-ratio dials, beat-frequency oscillator for C.W.—are some of the features of this set intended for aviation work. Special protection, by careful impregnation, makes it highly resistant to climatic changes.

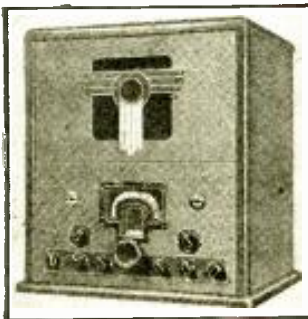

Speaker unit above, receiver below. (1223)

SERVICE OSCILLOSCOPE (1224)

(Paragon Radio Products)

COMPLETE or in kit form, this visual alignment instrument is available for modern servicing work, in which it is becoming more of a necessity daily. It incorporates, in an 8 $\frac{1}{2}$ x 8 $\frac{1}{2}$ x 14 $\frac{1}{2}$ in. deep metal case, (having an etched aluminum front panel) 6 tubes; 3-in. cathode-ray tube, a 903; 2 57s, vertical and horizontal amplifiers; 8K5 timing oscillator; 143-D for high-voltage,

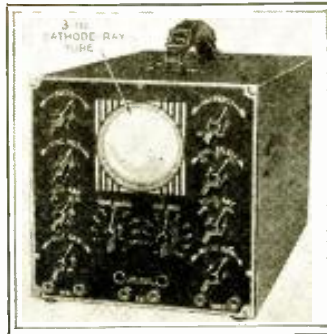

You can build from kit. (1224)

and 80 for low-voltage rectification. The sweep control is calibrated in 9 steps from 10 cycles to 20,000 cycles: one control "locks" the image on the screen; while others change over from the timing oscillator to external synchronizing voltages, or 60-cycle line, etc. The instrument may be installed permanently, or carried by its demountable handle.

POCKET MULTI-METER (1225)

(Readrite Meter Works)

EIGHT ranges controlled by a knob, on this compact instrument (3 1/16 x 2 3/4 x 5 7/8 ins. long) permit D.C. measurements up to 750 V., 150 ma., or 0.1-meg. with internal battery. Higher resistances may be read with external batteries. It is suitable for home servicing and many other types of electrical work; accuracy of readings said to be within 2 per cent. Furnished with battery, and leads with test clips.



Slides into coat pocket. (1225)

RADIO INTERFERENCE KIT (1226)

(Philco Radio & Television Corp.)

AS shown, this assortment is intended to meet requirements of the fight on man-made static with various units, of increasing rating, which can be attached to trouble-makers. They rate from a single condenser, to be put across motor leads to bypass R.F., or a choke which blocks R.F. in a line, to combinations of condensers and chokes for more serious cases, and resistors for high-voltage apparatus where condensers would be too bulky and expensive. The highest-duty types, not shown here, are for flashing signs and the like; but the exceptionally complete outfit illustrated is for home and shop use, and accompanied by full instructions.



Select one most suitable. (1226)

IRON-CORE-TUNED CODE-INTERFERENCE WAVE-TRAP (1227)

MODERN superhets., unfortunately, have an I.F. in the ship-shore communication band and, in some localities, it is annoying. This trap, tuned by a magnetic core, suppresses unwanted signals effectively before they reach the receiver. It is adjusted for best local efficiency.

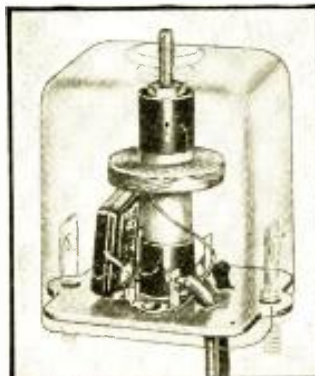

Tunes-out that "da-dit." (1227)

REPLACEMENT CONDENSERS FOR SERVICING (1228)

FLOOD- and heat-proof, these metal-sealed electrolytic condensers may be soldered to a chassis, as

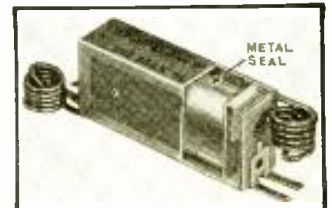

Small, rugged electrolytic condenser for service replacements (1228)

Name and address of any manufacturer will be sent on receipt of a self-addressed, stamped envelope. Kindly give (number) in above description of device.

well as bolted or clamped in place. They are small in size; surge-proofed by cellophane separators and electrolyte sparking only under high voltage; and made in values for replacements in all sets.

PERMANENT-TUNE I.F. TRANSFORMERS (1229) (Meissner Mfg. Co.)

WITH leads and air-tuned condensers which lock in place, this new type of I.F. transformer is built to hold its alignment, once set. Ten turns of adjustment permit micrometer setting. The transformers, top-tuned, are available from 170 to 3,100 kc., in air-core or new "ferrocarr" iron-core, for all types of circuits. Weatherproof.

COIL-CONDENSER CHECKER (1230)

PRECISE measurement, not only of capacity or inductance, for matching, but also of the efficiency of the instruments, is obtained by this laboratory development for use in mass production of radio components. A scale permits measurement, within determined limits of tolerance, of frequency variations, and losses ("Q") with great rapidity.



For mass precision work. (1230)



Hides in decorations. (1231)

"DETECTIVE"-TYPE CRYSTAL "MIKE" (1231)

CONCEALMENT of this microphone, yet effective pick-up, is easy; it is a cushion-mounted, single-diaphragm crystal type, for use with a long cable without serious output loss. It has a wide-angle unidirectional pick-up, and output level of -56 db., with a 5-meg. load. Weight 3 1/2 ozs. Has flat back, dome front and spring clip for attachment. Due to its small dimensions it is particularly satisfactory for detective work.



Neat automotive accessory. (1232)

WINDSHIELD DEFROSTER (1232)

COMPACT, constant-speed, this car windshield defroster has especially light drain on the battery—less than the tail-lights. It will keep the glass clear, by a steady air stream, while the motor is idle. It clamps anywhere, ball-socket mounting giving universal adjustment. 8-watt motor, 6-8 volts, 3 1/2-in. 2-bladed fan, 3,600 r.p.m., graphite bronze bearings. Brown enamel housing does not reflect glare.



This "cans" line noise. (1233)

"MAN-MADE STATIC" FILTER (1233)

(Continental Carbon, Inc.)

SOME static comes in through the aerial, as it has always done; but the electric set gets also all the noise on the power lines, which are connected to innumerable sparking motors and other devices. This can-type filter (double choke-condenser) grounds outside line noise before it

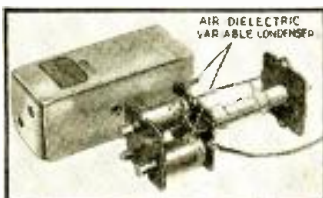

Made to stay aligned. (1229)

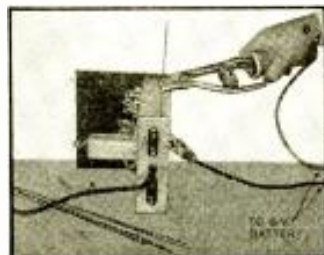

For sheet and wire work. (1234)

gets into the house, and so keeps it out of the radio set. Size 4 3/8 x 3 ins. diam., rating 10 A.

PORTABLE WELDER OUTFIT (1234)

FOR radio jobs, as for many others, this converts the car or other 6-V. battery into welding equipment. Tongs to grip carbon electrode, and 6-ft. cable with battery clip are easily carried. Current, 20-25 A. at 6 V. Comparatively heavy work, as well as soldering and brazing, can be done.

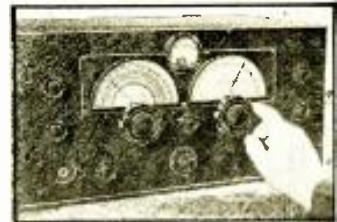

Radio professional's set. (1235)

CRYSTAL FILTER RECEIVER (1235)

FOR high selectivity, this receiver is engineered with a crystal in the input of the I.F. amplifier, permitting tuning so sharp as to cut out all interference, particularly for code reception; this may be either broadened to receive voice, or cut out for ordinary radio reception. Sensitivity, 1 microvolt absolute. Tunes from 550 kc. down to 32 mc. (9.38 meters). For amateur and commercial use.



Gives highly exact readings. (1236)

V.-T. AND PEAK A.C. VOLTMETER (1236) (Clough-Brengle Co.)

FOR R.F. as well as A.F. circuits, and those of small currents, this instrument has been brought out. Its range as a vacuum-tube meter is 0 to 1.2 V. without shunts, read on a 4 1/4-in. fan-type meter. The 6F5 tube (on the end of a 30-in. cable) can be connected through its cap directly into the circuit it is to measure, eliminating capacity effects of leads; or placed in the case, for lower-frequency work, with connections through the front binding posts. For a peak voltmeter, there are ranges of 0-10 and 0-100 V. and biases may be read accurately, as well as peaks of irregular waveform. Housed in a metal carrying case.



Will stand every tug. (1237)

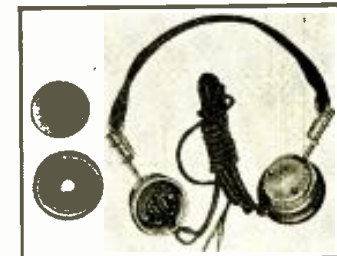

Inexpensive but effective. (1238)

STRAIN-PROOF PLUG (1237)

ELECTRIC connections are not made to stand much traction; and the ordinary receptacle plug is soon strained until the contact is bad. This new design keeps the pull off the wires; the plug may safely be yanked out by the cord, without stooping to get hold of it.

LOW-PRICED HEADSET (1238)

(Trimm Radio Mfg. Co.)

TO meet the requirement of phones giving good quality, at low price, especially for hospital and other institutions where headphone reception is needed from a central receiver or address system, as well as for S.-W. and other radio listening and experiment, this new bipolar set has been brought out.

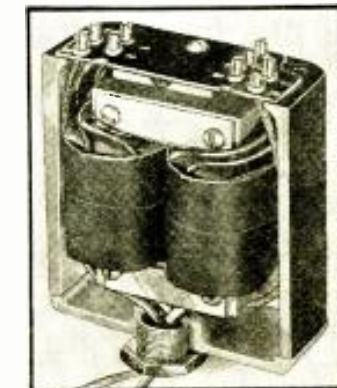

Latest transformer type. (1239)

HIGH-QUALITY A.F. TRANSFORMER (1239)

(Thordarson Electric Mfg. Co.)

FOR microphone, P.E. cell, tube or line-speaker coupling, this new line of transformers offers high fidelity, with numerous improvements. Dual, balanced coils are mounted on laminated high-permeability cores bound by non-magnetic clamps. Terminals can be removed without affecting shielding; reversible 1-hole mounting permits turning



Made like a jewel box. (1240)

PHILCO MODEL '37—116 Codes 121 (Shadowmeter) and 122 (Dial Tuning)

(See complete circuit diagram on Sheet 187, opposite page.)

(High Fidelity; 530 to 18,200 kc.; Magnetic Tuning (A.F.C.); Automatic Dial on Code 122; 15 tubes (glass); Bass and Treble Tone Controls.)

This all-wave receiver is intended for use with the Philco High-Efficiency Aerial; as it is designed for foreign-broadcast reception on short waves, as well as the standard long-wave bands. If used with this, the red and black terminals of the transmission line are connected to terminals 1 and 2, respectively. With an aerial of ordinary type, the connector strap is shifted to rest across terminals 2 and 3; the aerial connected to 1 and the ground to 3.

Both codes include Magnetic Tuning which, with the aid of the Discriminator Tube V8, gives automatic-frequency control ("A.F.C."). The Shadow Meter is a visual tuning indicator, showing when resonance has been obtained (by the thinness of the shadow cast by a rotating vane, connected with a coil, like

reception is obtained; the pressure is released and twisting continued until the screw jumps back into its original position. The automatic tuning is now set for that station; and call letters are inserted in the slot below the screw.

To remove the dial, 2 screws holding the handle to the hub are removed; and then 5 screws holding the escutcheon plate to the dial body. The dial may then be removed; 2 fibre and one metal ring will be found around the outer edges. These rings must be taken off to remove the assembly; in replacing them, the spring along the bottom edge of the metal ring must be in correct position, or vibration will be introduced. When the escutcheon is off, control screws may be removed by turning them until the indexing pin on the side end of the screw is centered in the small semicircular slot on the side of the housing; the screw may be then lifted out. (It may be necessary to move it slightly, to mesh its teeth with those in the hole.) To replace, insert screw in hole, turn it half around under pressure until stop on its side will clear shoulder on dial cover hole.

To adjust receiver, it is necessary dial be in alignment with condenser. Loosen coupling on condenser shaft, and turn condenser until plates are completely in. Set light beam on index line at low-frequency end of B.C. band; then tighten screws. Turn control until indicator is on first division; loosen screws; turn dial until indicator is on index line again; tighten.

Adjustment of I.F. compensators is as follows: (see diagram of compensators) with B.C. range on, M.T. switch off, dial at 580 kc. and test oscillator at 470 kc. connected by condenser to grid of V2. Adjust C29, C28, C31, C30, C33, and C32, in order for maximum output on meter. Turn "Tre.-Sel." control counter-clockwise to "expanded" position; shift oscillator frequency slowly from 460 to 480 kc. Two peaks will appear on meter—about 465 and 475 kc. They are equalized by readjusting C33. Then turn back "Tre.-Sel." control and adjust oscillator coupling for maximum output. Then tune C34 to minimum output.

To adjust the Magnetic Tuning control, leave selector switch on band 1, "Tre.-Sel." control to right and M.T. out. Set oscillator to 1,000 kc. and tune set for max. output. (Tuning control must be accurately adjusted, also oscillator for max.) Turn on M.T. control and adjust C35 for max. output. If meter goes off scale, turn down volume control. Turn off M.T.; the tone of the receiver should not change; if it does, a shift in frequency is shown, and the adjustment repeated.

The I.F. of this receiver is 470 kc. as in other '37 models of this company, instead of 460 kc., as before. The reason is to minimize commercial code interference.

The R.F. stages, built on the new Philco unit plan, are removable.

The R.F. cir.cuits are adjusted as follows; with test oscillator connected across terminals 1 and 3 of the input strip, and the strap



across 2 and 3. With an 18 mc. signal, and the range switch on position 5 (shortest waves), selectivity switch turned to right and M.T. off, turn oscillator compensator C22 clockwise to maximum capacity; then back until a second maximum peak is read on the meter (the first peak from maximum capacity is the image signal, to which the receiver must not be adjusted.) On some receivers, only one peak will be found; adjust C22 to this. If this is correctly done, the image signal will be found also at 17.06 mc. by advancing the oscillator input and tuning the receiver dial to this figure. Leaving the oscillator and receiver dials at 18 mc., the antenna and R.F. compensators C5 and C14 are now adjusted by connecting a variable condenser across C22 and ground and tuning it until the 2nd-harmonic of the receiver oscillator beats against the input, resulting in maximum indication. Units C5 and C14 are now readjusted for maximum output; after which, remove external condenser and readjust C22.

At 12 mc., C27, C17 and C8 are likewise adjusted; then C5, C14 and C22 for any error that this may have caused in high-end settings.

For tuning range 4, the adjustments are made likewise at 11 mc. and 7.5 mc. The oscillator compensator is C21; the antenna and R.F. compensators C4 and C13, for higher frequency; those for lower frequency, C26, C16, and C7.

For range 3, settings are made on 7 and on 5 mc., with the corresponding compensators to those used before.

For range 2, on 4.5 and 1.7 mc. Here we have only single R.F. and Ant. compensators C11 and C2, instead of a pair of each, to adjust. Osc. compensator C19 is first adjusted with them; then C23; then C19 again.

For range 1, broadcast, 1,500 and 580 kc. signals are used. The compensators C18, C10, C1 and C24 are likewise varied until no gain in output-meter reading can be obtained.

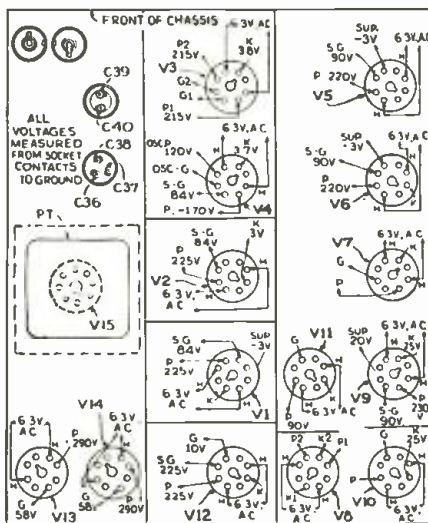

that of a meter, recording the plate current of V2). It is used only in Code 121 receivers. A.F.C. will correct an off-tune error of several kc. but, for several reasons, it is better that the dial shall be turned as near as possible to correct setting. The set owner is recommended to practice tuning with the Magnetic Tuning ("M.T.") control "Out," to become familiar with the wave ranges; and in tuning a weak distant station, near a more powerful one, it may be necessary to leave the M.T. system off; since the effect of A.F.C. is to pull in the most powerful carrier within 5 kc.

In Code 122 receivers the Shadow Meter is omitted, as the circuit diagram shows, and the Automatic Dial introduced to enable quick settings. This has 19 windows for station-name tabs; but it is not recommended to use more than 6 or 8, to avoid increasing the difficulty of selection.

As with a telephone dial, the handle is inserted in the proper window, pulled down to the bottom, and released. The red circle, which takes the place of the 20th window, cannot be turned past the bottom; otherwise, the dial rotates in either direction. The receiver is furnished with sheets of station-call letters. To make adjustments for those desired, the set is turned on, with the range selector on position 1 (B.C. band) and the M.T. control out. The metal plate over the handle "finger" is taken off (see photo) by removing tuning knobs and 3 screws; this uncovers the "control screws." The set is tuned to the desired station; the screwdriver inserted in the control screw nearest the bottom and turned back and forth until a click is heard, indicating that the control screw has engaged the locking mechanism. Then the dial is adjusted by twisting the control screw back and forth until best

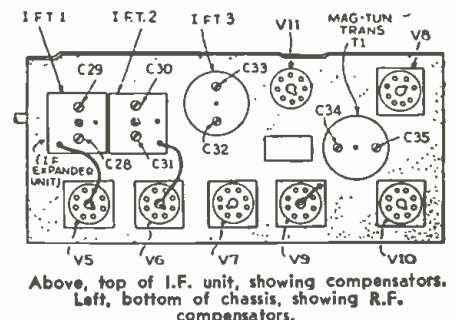
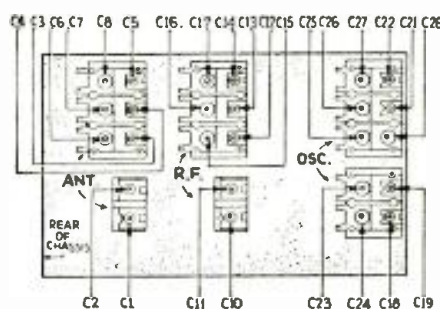

PHILCO MODEL '37—116 Codes 121 (Shadowmeter) and 122 (Dial Tuning) (Continued)

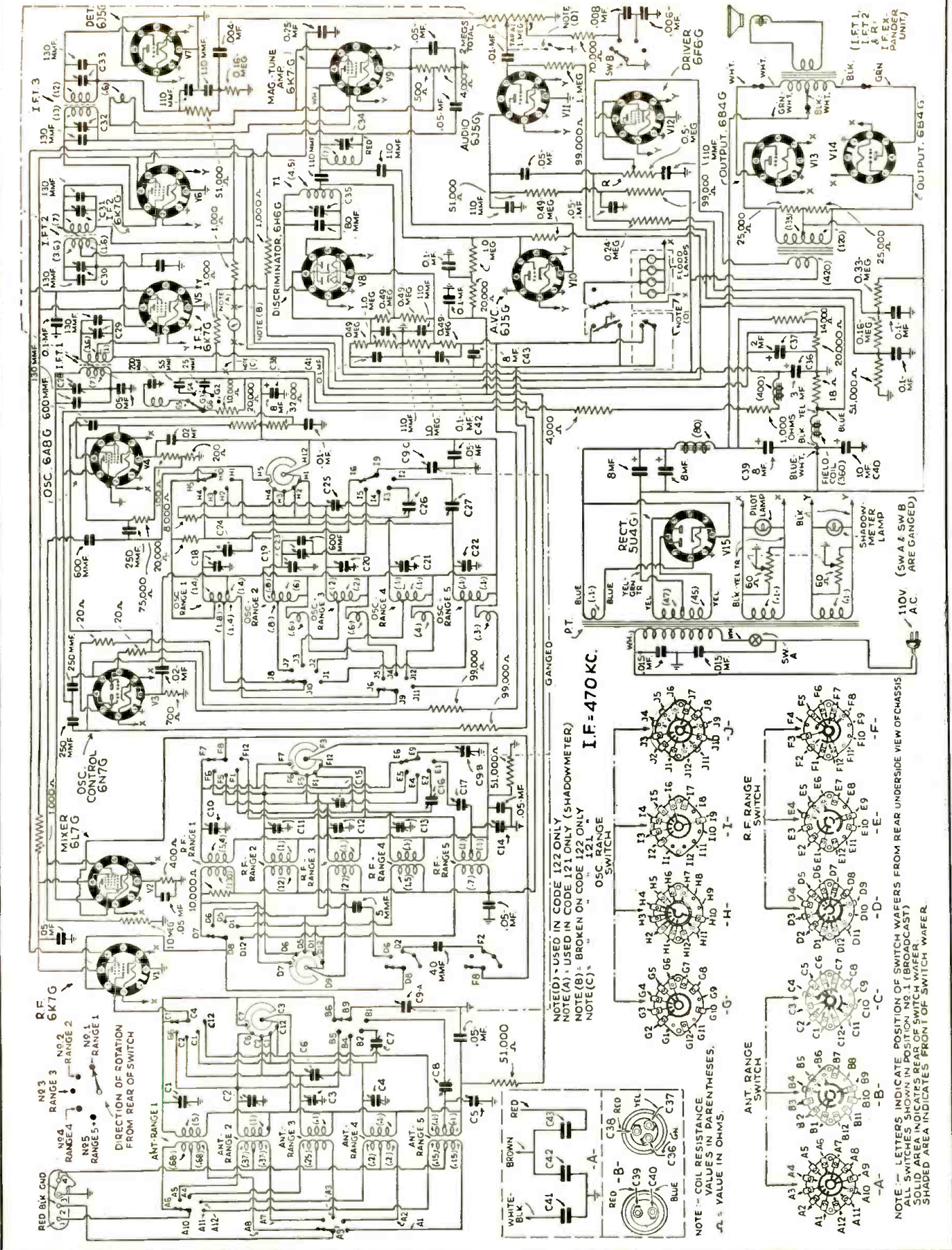

ANALYSES of RADIO RECEIVER SYMPTOMS

OPERATING NOTES

Kolster K-70, K-72, K-80, K-82, K-90. Noisy tuning, and circuit oscillation are frequent causes for complaint on these models. In some cases, tuning is very erratic. Invariably, the trouble has been found due to corroded condenser-gang rotor contacts. This may be corrected by cleaning the contacts and bending them to increase their tension. A pigtail should be installed between rotor shaft and chassis for a permanent repair.

When an inoperative receiver is encountered, which functions as soon as the A.V.C. 24A tube is withdrawn from its socket, but with distortion and no control of volume, check the 2-meg. A.V.C. gridleak for an open-circuited condition. In the models 90 and 92, the normal value for this resistor is 1 meg.

An insensitive receiver with almost total inoperation on the less-powerful stations is usually the result of excessive control-grid bias on the R.F. and I.F. tubes. In some very few cases, replacement of the A.V.C. tube will overcome the trouble, especially with a tube having low emission, since the lowered plate current will produce a lower voltage drop across the 2-meg. resistor connected from the plate of the A.V.C. tube to ground. However, it has been found necessary in the majority of instances, to reduce the value of this A.V.C. plate resistor to 1 meg. or even lower, so as to decrease the voltage drop and consequently the control-grid bias on the R.F. and I.F. tubes. It is inadvisable

to employ a resistor whose value is lower than 0.5-meg. as the plate load resistor, since (a) the inability to properly control volume and (b) insufficient A.V.C. action will be noted. It has been found best to reduce the value of both the A.V.C. plate resistor and grid resistor, until satisfactory operation results.

When the receiver operates at maximum volume but with a certain degree of distortion, with the volume control being ineffective, check the continuity of the A.V.C. grid circuit with respect to chassis. This requires an ohmmeter capable of measuring resistance values to at least 1 meg. Leakage in the insulated terminal brackets employed in the A.V.C. grid circuit is the cause for the condition described.

Highly distorted reception at any volume level, with the attendant circumstance of no A.V.C. action, is due to an open-circuited A.V.C. grid-coupling condenser—a 500-mmf. unit connected between the plate of the I.F. tube and the grid of the A.V.C. 24A.

One of the most common complaints with these models lies with the time lag of the volume control. By this is meant that a moment or two is required for the volume to build up, or vice versa, as the volume control is manipulated, unless the latter is rotated very slowly and deliberately. The trouble is overcome to some extent by decreasing the value of the A.V.C. plate resistor as mentioned above; but by replacing the R.F. and I.F. grid filter con-

densers with lower-value units, but not lower than 0.01-mf., the condition is partially remedied. Lowering the value of the grid filter resistors will also lower the time constant of the A.V.C.

In the models K-70, and K-72, when an inoperative receiver is serviced and plate and screen-grid voltages on all tubes but the A.V.C. tube are found lower than normal, and a reading of more than 250 V. is obtained on the cathode of the A.V.C. tube rather than the normal 50 V., check the 200-ohm section of the voltage divider for an open-circuit.

Circuit oscillation, motorboating, and the condition wherein rattling sounds are produced upon vibration of the chassis or when weak stations are tuned-in, have been traced to poorly grounded coil shields resulting from loose or oxidized shield rivets. The remedy is obvious, we hope.

Lyric SA-91, SA-99, 900. These models are frequently serviced for the complaint of no inter-station noise suppression. The silent tuning system operates by biasing the 1st-audio 57 to cut off when no signal is being received. When it is found that adjustment of the manual noise-suppressor control produces little, if any at all, effect upon inter-station noise, look for a leaky or short-circuited 1st-audio cathode bypass condenser, a 10-mf. electrolytic unit. The failure of this condenser not only produces the symptoms de-

scribed, but also introduces a highly microphonic condition which can be eliminated only by slightly de-tuning the station selector.

Lyric SA91, 99, 900. The complaint of circuit oscillation, particularly at the higher frequencies, has been found to be caused by an open-circuited 0.5-mf. condenser bypassing the R.F., first detector and I.F. screen-grid circuits and oscillator plate circuit. This unit is of the usual tubular type, the open circuit being produced by poor internal contact of the pigtail leads.

When these receivers are serviced for an inoperative condition and the plates of the 80-type rectifier heat excessively, check the I.F. transformers for a short-circuit between the primary winding and shield. These transformers are of the thimble type. In some cases, insufficient insulating compound within the assembly, or loosening of the compound due to heat, causes the primary winding to contact the shield can. Replacement is not always essential as the transformer may be removed from the can by the application of some heat, and replaced after the shield has been lined with a sheet of insulating paper.

Lyric SA-120, 1200. Failure to obtain inter-station noise suppression, as with the model SA-91, may be traced to a leaky or short-circuited 1st-audio cathode bypass (Continued on page 439)

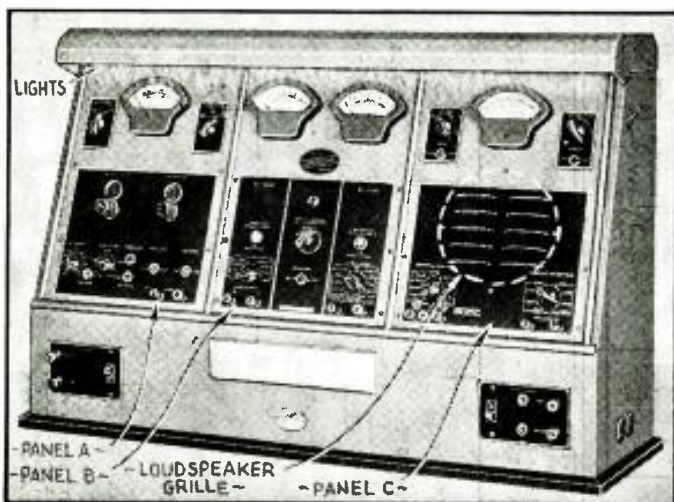

Fig. A. Panel A is an all-wave oscillator and output meter; Panel B combines an A.C. and D.C. voltmeter, milliammeter, ohmmeter and capacity tester; Panel C contains a universal replacement speaker and a vibrator tester. Other functions are described.

INTENDED to service any make or type of radio set, but with especial features permitting attention to the increasing business in car sets, this universal test panel is an especially attractive piece of equipment, presenting not only the technical details to facilitate the work of the Service Man, but the appearance to impress the customer who sees it in use. It is of bench dimensions—22½ x 11 x 35 ins. long. In view of the fact that certain elements of radio practice have not yet reached their ultimate development, the tube checker is not included in the unit.

However, the panel incorporates (left-section) a tuned-plate oscillator or signal generator, calibrated from 100 kc. to 30 mc., with hand-calibrated charts to ½ of 1 per cent accuracy over range; and a 400-cycle modulator. Both oscillator and modulator are 6C5s, powered by an 84. Each tuning band is covered by a double-action dial with 100 divisions for each quarter-turn. The large dials, a feature of this apparatus, are illuminated by

NEWEST CAR-RADIO SERVICING PANEL

An elaborate testing instrument for auto-radio shops and garages—it is made for servicing even the set models of 1937.

tubular lamps from above. The output meter, calibrated 0-0.1, and -1.0 and -10 watts, and 0-10 and 0-100 V. A.C. is connected internally to a universal loudspeaker and externally to binding posts. A jack permits plugging-in a cathode-ray modulator. A fully-shielded attenuator gives control of signal output, having 5 multipliers, each in a ratio of 10 to 1. See Fig. 1A.

The center panel, with A.C. and D.C. meters, ranging up to 800 and 500 V., respectively, has a capacity meter reading directly, in 3 ranges, from 500 mmf. up to 16 mf., and an ohmmeter with 5 ranges from zero up to 20 megohms. The D.C. milliammeter readings have 3 ranges up to 500 ma. See Fig. 1B.

For the special purpose of testing voltage and current to car-radio sets, there is a volt-ammeter, permanently connected to a 6-V. supply—reading up to 10 V., or 20 A. Car-radio vibrators are tested, without removal from the receiver, by regulating the input voltage with a rheostat, and noting the point at which the vibrator begins to operate—which should be 5 V. or less. The condition of the rectifying contact is checked by measuring the voltage of the receiver; while the measurement of set output indicates the condition of the tubes. See Fig. 1C.

The right-hand panel contains a universal test speaker, with permanent magnetic field, and a built-in substitute speaker field, with adjustable resistance, for use in testing those sets in which the speaker field is part of the power circuit, yet removable. The speaker is behind the louvre openings in the center of the panel; above it, the D.C. volt-ammeter scale, with polarity meter at the left, and vibrator switch right. Below, left, speaker load matching control and, right, substitute speaker field had. (Continued on page 438)

SAVE UP TO 50% DIRECT FROM MIDWEST FACTORY!

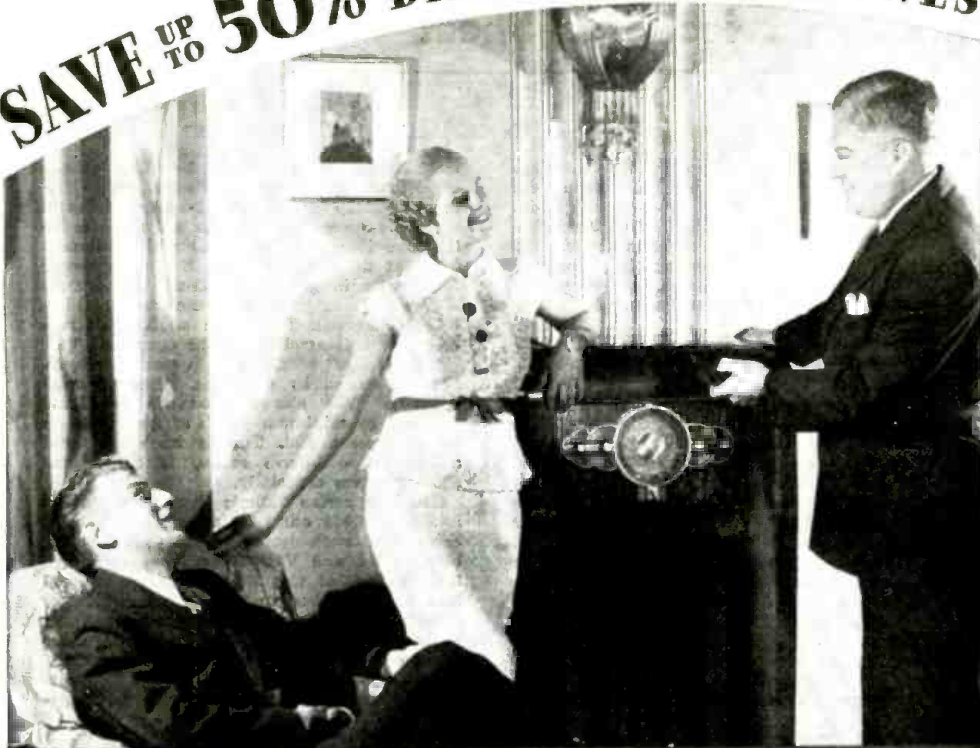

**"I REMEMBER WHEN RADIO FIRST STARTED...
EVEN THEN MIDWEST WAS KNOWN FOR ITS
Power AND Beauty!"**

**MAIL COUPON *Now* FOR NEW
FREE 40-PAGE CATALOG**

Mail coupon today for new, FREE 40-page catalog...and learn how you can save up to 50% by buying direct from Midwest factory. See for yourself that Midwest offers today's greatest radio values, and scores of exciting features, like Dial-A-Matic Tuning, plus Elektrik-Saver. With the sensational Dial-A-Matic Tuning feature, for example, even a child can bring in ten perfectly tuned programs in ten seconds. Zip! . . . Zip! . . . Zip! . . . stations come in instantly, automatically, perfectly . . . as fast as you can push buttons. The exclusive Midwest Elektrik-Saver cuts radio wattage consumption 50%, enables Midwest radios to use no more current than ordinary 7-tube sets.

**ONLY IN MIDWEST DO YOU GET
DIAL-A-MATIC TUNING *plus* ELEKTRIK-SAVER**



DIAL-A-MATIC TUNING

Now, even a child can bring in ten perfectly tuned programs in ten seconds! It's a big thrill to whirl the dial . . . and then hear the station you want . . . come in instantly, automatically . . . as fast as you can press buttons!



ELEKTRIK-SAVER

This exclusive Midwest feature cuts radio wattage consumption 50% . . . results in Midwest radios using no more current than ordinary 7-tube set . . . enables you to operate on voltages as low as 80 volts.

Only
\$59.50 COMPLETE
with
GIANT
THEATRE-SONIC
SPEAKER
(LESS TUBES)
TERMS
AS LOW AS
10¢ A DAY



**30
DAYS
FREE TRIAL**

You have a year to pay...terms as low as 10c a day...you secure privilege of 30 days' FREE trial in your own home. In addition, you are triply protected with Foreign Reception Guarantee, One-Year Warranty and Money-Back Guarantee.

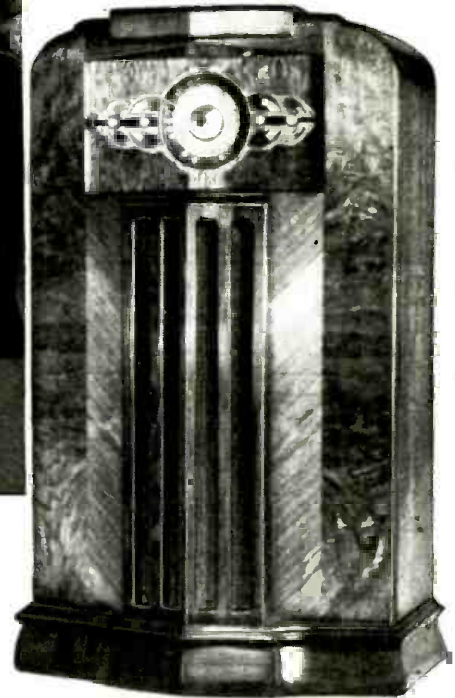

**18 TUBES
SIX WAVE BANDS
4½ to 2400 METERS**

Bigger, better, more powerful, more beautiful, this super deluxe Midwest out-performs \$150 sets on a point-for-point comparison. Amazingly selective, delicately sensitive, it brings in distant foreign stations with full loud speaker volume on channels adjacent to powerful locals. You'll thrill over its marvelous super-performance...glorious crystal-clear "concert realism" . . . magnificent world-wide foreign reception. Powerful Triple-Twin tubes (two tubes in one) give 22-tube results. You can switch instantly from American programs . . . to Canadian, police, amateur, commercial, airplane, ship broadcasts . . . to the finest and most fascinating foreign programs. Never before so much radio for so little money. Why pay more? Save up to 50% by buying at wholesale . . . direct from factory...preferred by thousands of careful radio purchasers since 1920.

**MAIL COUPON TODAY FOR FREE 30-DAY
TRIAL OFFER AND 40-PAGE FOUR-COLOR FREE CATALOG**

MIDWEST RADIO CORPORATION
Dept. G-12
Cincinnati, Ohio
Without obligation on my part, send me your new FREE catalog and complete details of your liberal 30-day FREE trial offer. This is NOT an order.

Name.....
Address.....
Town..... State.....
(Special offer and prices prevail only when dealing direct with factory by mail.)



MIDWEST RADIO CORP.
DEPT. G-12 CINCINNATI, OHIO, U.S.A.
Established 1920 Cable Address MIRACQ...All Codes

Please Say That You Saw It in RADIO-CRAFT

RCA VICTOR MODELS 9T AND 9K2 9-TUBE, 5- TO 566-METER (BEAM POWER OUTPUT) SET

Magic Brain 5-band tuning unit; Magic Eye cathode-ray tuning tube; Magic Voice (in 9K2) cabinet; "Music-Speech" tone control.



The 9K2 cabinet, with back open, shown by reflection. At the bottom, "Magic Voice" tubes, preventing low-note resonance.

The two models are alike in all but cabinet and reproducer; 9T, table type, has an 8-in. speaker; 9K2, console type, with 12-in. speaker, incorporates the "Magic Voice," 5 metal open-end tubes inserted in the cabinet base, to make low tones emerge in phase, and thereby eliminate boominess, or reverberation. (The model 9K2 is illustrated.)

The R.F., oscillator and 1st-det. stages form a detachable unit ("Magic Brain") feeding the 460-kc. I.F. amplifier. The 5 bands are X, 150-410 kc.; A, broadcast, 530-1,800 kc.; B, medium, 1,800-6,400 kc.; C, short-wave, 6.4 to 23 megacycles; D, ultra-S.W., 23-60 mc.

An unusual method of switching is used in the antenna and detector circuits, by which parts of the same windings are used in more than one range; the oscillator stage, for greater stability, uses separate windings. Thus coil "X" is part of the secondary, in the X band, and "X Pri." transmits the input signal; in the "A" band, "X" becomes the primary, leaving "A", "B", "C" in the secondary; etc. For band D, a separate 1-turn coil is used. Consult switching details above and coil connections shown (right). The I.F. transformers are new "magnetite" type, with

fixed condensers, and tuned by adjusting the cores to obtain correct inductance. Magnetite-core wavetrap L1 cuts out 460-kc. interference.

"Music-Speech" control is an addition to the tone-filter (on Vol. Con.) which balances tones at different settings; Sw.5 (on power Sw.4) cuts in additional 0.1-mf. capacity to reduce L.F. response and increase intelligibility of speech. This is in addition to regular "Tone Control" over the output of V7.

"Magic Eye" tube, V8, with maximum voltage (developed by 0.22-meg. resistor across input of V5) shows resonance to signal tuned-in by minimum width of dark area on its fluorescent end. Tuning knob has 20:1 and 100:1 dial-drive ratios, latter for the shorter waves especially.

The bias across "Magic Eye" bias resistor, and the 56,000 ohms in series with it, also controls through detector-diode (V5, 5-8) the bias of V2 and V4; the other (auxiliary—3,4) section of this diode supplies residual bias to the tubes under conditions of low signal, but ceases to draw current on heavy signals, and the A.V.C. side of the diode takes over the whole biasing function.

Under normal conditions, tube cathode currents are read, at the sockets, under voltage-

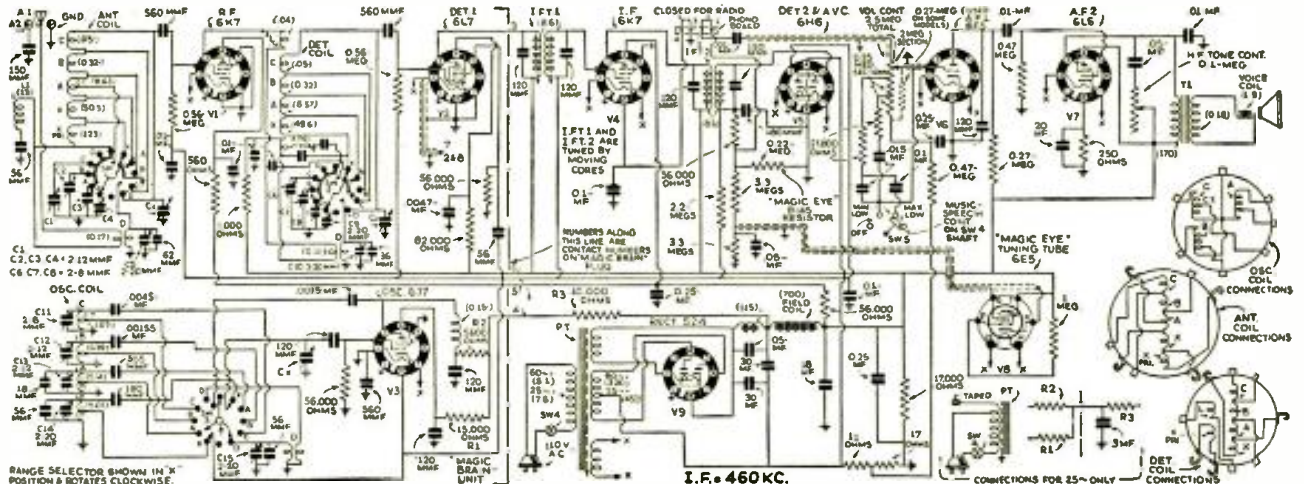

For phonograph connections, link "Closed for Radio" is removed, and phono-radio switch connected in. Tube V8 is "Magic Eye."

reading settings (1,000 kc., no signal, Vol. Con. minimum), as follows:

Tube V1, 8 ma.; V2, 4.4; V3, 6.7; V4, 8.0; V5, 0; V6, 0.3; V7, 63.0; V8, 3.0. V9 draws 110 ma.

Factory settings of the R.F. trimmers in the "Magic Brain" are about as follows (top of trimmer to chassis base), in inches:

Band	X	A	B	C	D
Osc.	1 1/2	1 1/2	1 3/4	1 7/16	1 1/2
Det.	1 15/16	1	1 1/4	1 1/4	1 7/8
Ant.	1 9/16	1 1/4	1 3/8	1 1/16	1 3/8

If these plunger-type, air-trimming condensers have been disturbed, they should be set approx. to above distances, before aligning.

As a guide to R.F. and Ant. coil settings, a "tuning wand" may be used. If the brass tip is inserted in the can, and output increased, this shows that the capacity should be decreased (plunger pulled out). And, vice versa.

Use the service-oscillator frequency that, of two (920 kc. apart), is 460 kc. lower than the receiver-osc. frequency. Align wavetrap

to minimum service osc. signal, through 200 mmf. at A1, of 460 kc.; the receiver, at the same time, is near 600 kc.

The R.F. adjustments on the "Magic Brain," with output meter or, preferably for accuracy, oscilloscope, are made in this order: wavetrap; and bands D, C, B, A, and X, respectively. There is one for the wavetrap; and 17 for the R.F. circuit. Generator output must be attenuated to lowest value giving a distinguishable signal, to avoid broadness of tuning which A.V.C. would otherwise cause.

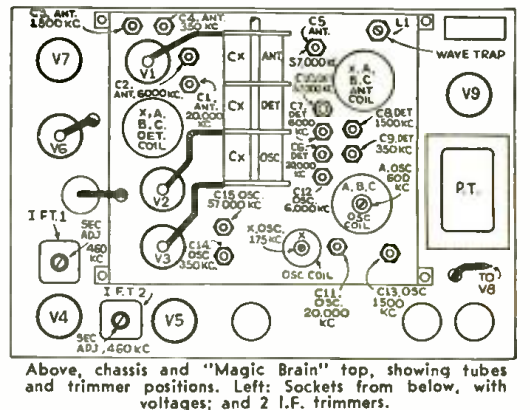
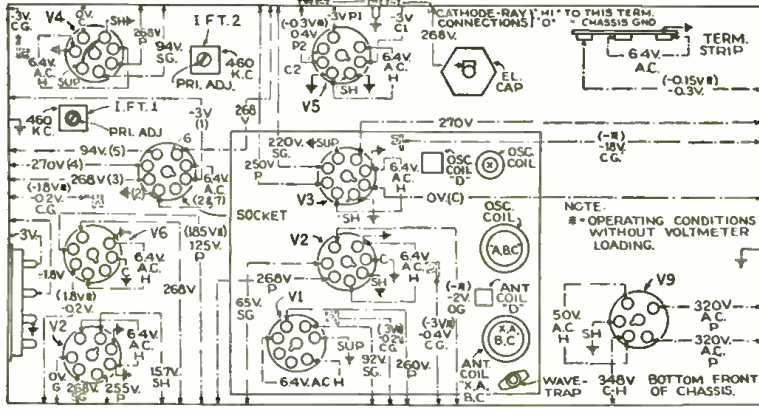

A NEW POLICY *Factory Prices*

TRIPLE LOAD OUTPUT TUBE TESTER

• Completely tests all tubes. • Selective Individual Element Tests, • Hot shorts and leakage check with sensitive neon Indicator. • Detects all Interelement leaks. • Beautiful Etched Plate in Ivory and Black. • Portable and Counter Style. • Write for full data. • F. O. B. factory.

Model 420L Tube Tester \$23.95



THE INDISPENSABLE MULTIRANGE METER

- Eleven Ranges. High Sensitivity.
- Measures A. C. and D. C. Volts.
- D. C. Current Resistance to 10 Megohms.
- Polarized cable and single selector switch.



Model 300 Multirange Meter

\$15.95

Write today for further particulars. Now offered at the low cost factory direct price. F. O. B.

Direct from factory saves you up to 35%.

Avoid big Interest Rates.

Eliminate Obsolete Tube Stock.

Complete Dealer Cooperation.

Money Back Guarantee

We stand back of every piece of testing equipment we sell direct. Your money cheerfully refunded on merchandise returned within 10 days in original condition.

TRIUMPH MANUFACTURING CO.

4017 W. Lake St.

Chicago, Ill.

Triumph Manufacturing Company
Dept. RC71 4017 Lake St., Chicago, Ill.
Check coupon and mail today
Dear Sir: At no obligation to me please send FREE brochure on the Triumph line of testing equipment.
Dear Sir: On the basis of your money-back guarantee please find enclosed 25% deposit (\$.....) Balance to be C.O.D. for model.....
Name.....
Street.....
City..... State.....

ULTRA-ULTRA-MICROWAVE "RADIO" OF THE FUTURE

(Continued from page 393)

idea, how complicated and clumsy our present radio receivers are in the final analysis.

We need coils and antennas to bring the signal of a transmitter to the control-grid of the first tube of our receiver. We require oscillator-mixer circuits to convert the R.F. signal received into an I.F. signal. Then follow the 2nd-detector, the A.F. amplifier and, finally, the reproducer or "loudspeaker."

Remembering that "radio" waves, and visible or invisible "light" rays are one and the same thing, but different only in their frequency, let's see how Dr. Zwoykin does the trick.

He needs no coils or tubes in the "input stage"; referring to Fig. B, only an extremely thin layer of a photo-sensitive chemical to receive the signal. This layer not only converts the incoming light signal into an impulse of another frequency, but also rectifies the signal into a direct current (D.C.) impulse, in the form of an electron emission. A second thin layer, made of a fluorescent material, is then used to reverse the conversion process.

However, while the first layer converts a signal downwards in frequency (transforms light impulse of high frequency into D.C. impulses of, theoretically, very low frequency), the second layer of fluorescent characteristic converts a signal of a low frequency (D.C. impulses) into a high frequency. Or, in other words, it converts the D.C. electron beam into visible light, which is a signal of very high frequency.

Today we are able to receive and to transmit signals in the range starting with the infra-red light and ending with the range of the ultra-violet light. Tomorrow, someone, somewhere, will find a new photo-sensitive chemical, or a new alloy (in the form of a combination photoelectric cell and thermo-element) which will do equivalent tricks in those parts of the wave spectrum which are as yet unconquered; namely the remaining spot between the outskirts of the infra-red rays and the shortest of the short radio waves.

As mentioned before, all the scientists working in this part of the spectrum have not yet announced their findings, but there are already certain indications which, when assembled in the proper order, give us an inkling into the future modes of radio communication, and the future trends of radio design.

Complicated receivers of today will shrink to a tiny glass ball, consisting in principle of two chemical layers, or even (and this is also of great interest) of 2 crystals.

A tiny "electron multiplier" arrangement, as it has been described by Dr. Zwoykin and Philo T. Farnsworth, will amplify the signals received by the first layer (or by the first crystal) employed. In case optical reception is desired, a fluorescent screen will transform the amplified electron beam into light impulses. In case musical reproduction is desired, a second crystal, employed as sound reproducer, will probably do the trick. The principal design of such a future radio receiver is shown in Fig. C. Experienced readers will say: "It must be quite simple to build such a receiver after Dr. Zwoykin did something similar with light rays, and since the Rochelle-salt crystal-loudspeaker is ready today as standard equipment." However, it only looks that way.

There are quite a number of physical problems unsolved; but there is firm hope that these will be mastered in time to come.

Upon consideration of the enormous number of wavelengths, available in the range of the Ultra-Ultra-Microwaves, everyone can picture himself in possession of his own receiver and his own wavelength allotted to him, in a manner similar to the way in which we acquire today license numbers for our cars. To make this true, another problem must first be conquered: "How shall we tune these receivers to receive desired programs?"

However, a solution already exists for this problem. Let's look how photographers interested in color-photography "tune" their cameras to "catch" only the image of certain colors of the object to be recorded. They place filters in front of the lens system. Colors (or to speak in the language of radio technicians—"frequencies") not desired by the photographers are "tuned-out"

(filtered) by means of a piece of stained glass and, since we also have to deal with waves of this frequency-band, similar tuning methods will probably be applied.

Finally there is another difficulty to expect. That is the "quasi-optical" nature of these tiny ultra-ultra-microwaves. Since their frequency approaches that of visible light, their range will be restricted, approximately, to a distance corresponding to the optical range of vision. Antennas of odd form will be required to enjoy programs, transmitted on these wavelengths, in the apartments of our great cities.

A forecast of such an antenna is shown in Fig. A. As this illustration indicates, a reflecting mirror, approximately horn shaped, is fastened at the top of a high post. This form of reflecting mirror is necessary to receive signals from all directions. And, below this mirror we see a funnel-shaped or concave device. This funnel contains a large number of tiny "ultra-ultra-microwave receivers" or receiver cells—much as the eye of a fly is constructed with innumerable facets, each of which is an "eye" in itself. They will probably be arranged in circles. Each circle, containing a great many of these receivers, is "tuned" by means of suitable filters to a certain frequency; and the amplified electron-emission will be sent via multiple-wire cable down to the selector mechanism or control unit and the sound reproducer in the apartment. Eventually the "tuning" (i.e., the movement of the filters) will be executed by remote-control devices from downstairs.

This all sounds quite expensive. But we should not forget the numerous and complicated parts contained in our present-day receivers, yet how much do we pay for a complete set? Or, for example: in the beginning of radio, we paid about \$50.00 for a radio tube of quite simple design. What is the present price for a complicated metal tube? All these price problems are questions concerning only the competing manufacturers. Our interest is to induce amateurs to think along the lines of the article.

Please Say That You Saw It in RADIO-CRAFT

**You Need it . . .
And it's FREE!**



**The New 1936-37 Edition
of Auto-Radio Installation
and Servicing**

One of the most expert radio engineering staffs in the world has written this book for you. And you're going to have plenty of opportunity to use it this winter.

Here are just a few of the important subjects covered in this valuable book: Elimination of motor interference for every make of 1936 car . . . Tube compliment chart for practically all models of automobile radio sets, with I.F. peak frequencies . . . Set and antenna installation hints, etc. These and hundreds of other problems you will meet in auto-radio installation and servicing are covered in this amazing book.

If this book were for sale you'd be willing to pay out a lot of money for it. But it isn't for sale! *It's absolutely free!* Just fill out the coupon below and send it to us.

Hygrade Sylvania Corporation, makers of Sylvania Radio Tubes and Hygrade Lamps. Factories at Emporium, Pa., Salem, Mass., and St. Mary's, Pa.

SYLVANIA
The Set-Tested Radio Tubes

HYGRADE SYLVANIA CORP. RC-17
EMPORIUM, PA.

Please send without obligation your new service book, "Auto-Radio Installation and Servicing".

Experimenter Amateur Call
Serviceman Employed by dealer
Independent

Member Service Organization

Name

Address

City State

Name of Jobber

Address

TECHNICIANS' DATA SERVICE

JOSEPH CALCATERRA

DIRECTOR

A special arrangement between RADIO-CRAFT magazine and the publishers of this literature, which permits bulk mailings to interested RADIO-CRAFT readers, eliminates the trouble and expense of writing to each individual organization represented in this department.

2. HAMMARLUND CATALOG. Contains complete specifications, illustrations and prices on the Hammarlund line of variable and adjustable condensers; intermediate frequency transformers, coils and coil forms; sockets; shields; chokes and miscellaneous parts for broadcast, short wave and ultra short wave reception and transmission. Also contains description and prices of the Hammarlund line of "Comet Pro" and "Super Pro" receivers.

5. ELECTRAD 1936 VOLUME CONTROL AND RESISTOR CATALOG. Contains 12 pages of data on Electrad standard and replacement volume controls. Truvolt adjustable resistors, vitreous wire-wound fixed and adjustable resistors and voltage dividers, precision wire-wound non-inductive resistors, center-tapped filament resistors, high-quality attenuators, power (50- and 150-watt) rheostats and other Electrad resistor specialties.

29. THE KEY TO SUCCESSFUL SERVICING. Four different types of combinations of courses on Radio Servicing, Public Address Work, and Television, developed by the Radio Service Institute, are described in this 24-page booklet. Complete information, including outlines of the courses and costs, is given. Two of the courses are designed for the more advanced and more ambitious Service Men who are anxious to get to the top of their profession. The other two courses are for less-experienced Service Men who want to Advance more rapidly in the Radio Servicing Field. Please do not ask for this booklet unless you are interested in taking a course in these subjects.

53. POLYIRON COIL DATA SHEET 536. This folder contains complete catalog descriptions, specifications, prices, performance curves and circuits showing applications of the complete line of Polyiron radio components made by the Aladdin Radio Industries, Inc.

57. RIBBON MICROPHONES AND HOW TO USE THEM. Describes the principles and operating characteristics of the Amperite velocity microphones. Also gives a diagram of an excellent humless A.C. and battery-operated preamplifier.

65. THE 1937 LINE OF SUPREME TESTING INSTRUMENTS. This 12-page catalog gives complete information on the entire Supreme line of testing instruments, including the Model 585 Diagnometer; the Model 540 and 550 Radio Testers; the Model 500 Automatic; the Model 505 Tube Tester; the Model 555 Diagnosticscope and other Supreme oscilloscopes, tube testers, signal generators and multimeters. Complete details of the Supreme Easy Payment Plan for purchasing testing equipment on the installment plan are also given.

73. HOW TO ELIMINATE RADIO INTERFERENCE. A handy folder which gives very complete information on how to determine and locate the sources of radio noise by means of the Sprague Interference Analyzer. A description of the analyzer and method of using it is included, together with data on how to eliminate interference of various kinds once the source is located.

74. SPRAGUE 1936 ELECTROLYTIC AND PAPER CONDENSER CATALOG. Gives specifications, with

Radio-Craft Technicians' Data Service
99 Hudson Street,
New York City, N. Y. RC-137

Please send to me, without charge or obligation, the catalog, booklets, etc. the numbers of which I have circled below.

2	5	29	53	57	65	73
74	75	76				

My radio connection is checked below:

- Service Man operating own business.
- Service Man for manufacturer.
- Service Man for jobber.
- Service Man for dealer.
- Service Man for servicing company.
- Dealer.
- Jobber.
- Experimenter.
- Professional Set Builder.
- Amateur Set Builder.
- Short Wave Work.
- Licensed Amateur.
- Station Operator.
- Radio Engineer.
- Laboratory Technician.
- Public Address Worker.
- Manufacturer's Executive.
- Student.
-

I am a:
 Subscriber Newsstand reader
 I buy approximately.....of radio material a month. (Please answer without exaggeration or not at all.)

Name

Address

City State.....

(Please print name and address)

Avoid delay. The catalogs and booklets listed are now in stock and will be sent promptly as long as the supply lasts. Please use this coupon in ordering. The use of a letter causes delay.

list and net prices on a complete line of wet and dry electrolytic, and paper condensers made by the Sprague Products Co. for radio Service Men, set builders, experimenters and engineers. Information on the Sprague Capacity Indicator, for making capacity tests on condensers and in servicing receivers, is included.

75. SPRAGUE TEL-U-HOW CONDENSER GUIDE. A valuable chart, compiled by the Sprague Products Co. which tells the proper types, capacity values and voltages of condensers required in the various circuits of radio receivers and amplifiers, and how to locate radio troubles due to defective condensers. Includes data on condenser calculations.

76. FACTS YOU SHOULD KNOW ABOUT CONDENSERS. A folder, prepared by the Sprague Products Co., which explains the importance of various characteristics of condensers, such as power-factor, leakage, capacity and voltage in determining the efficiency or suitability of a given condenser to provide maximum filtering and safety in operation.

UNCLE SAM'S WAR AGAINST "BOOTLEG" S.-W. TRANSMITTERS

(Continued from page 406)

\$10,000 or by imprisonment for a term of not more than 2 years, or both."

"Section 502. Any person who willfully and knowingly violates any rule, regulation, restriction, or condition made or imposed by the Commission under authority of this Act, or any rule, regulation, restriction, or condition made or imposed by any international radio or wire communications treaty or convention, or regulations annexed thereto, to which the United States is or may hereafter become a party, shall, in addition to any other penalties provided by law, be punished, upon conviction thereof, by a fine of not more than \$500 for each and every day

during which such offense occurs."

All persons who desire to construct and operate a transmitter of any type are required to obtain authority to do so from the Commission. (Appropriate forms to be used in applying for construction permits and licenses will be furnished upon request.)

A copy of this letter should be delivered with each transceiver or other type of transmitter sold; and a statement should be made in catalogues or descriptive literature, for the information of prospective purchasers, that a license from the Federal Communications Commission is required for the operation of such equipment.

Please Say That You Saw It in RADIO-CRAFT

MODERN SHORT-WAVE DIATHERMY

(Continued from page 404)

pared with the new (short-wave diathermy). In Fig. 1 is a diagram typical of the newer oscillatory circuits; it is this type of equipment which is used in the short-wave method of diathermy illustrated at the right in Fig. 11.

Naturally, there can still be heard a few dissenting voices from the old school of thought. However, the conclusive results obtained in experimentation and in practice will undoubtedly silence them soon enough.

I cite, for example, the work of Dr. John S. Coulter of Northwestern University Medical School. After much research he found that the short-wave diathermy machine constituted the most effective method for the creation of deep heat in the body. Dr. Coulter proved this by conducting tests at the University for which 40 students volunteered to act as subjects. A special thermocouple thermometer, in the form of a large hypodermic needle, was inserted 2 ins. deep into the muscle of each student, and the exact temperature rises were recorded during the short-wave heat application. The average rise in the muscle was about 6 deg. F., with the instrument registering in some cases as high as 106 deg. F.

Although the specific frequency used in short-wave therapy seems to make no difference in the result of the treatment, there is no doubt that the higher frequencies used do produce a more intense heating effect upon certain tissues.

IS SHORT-WAVE DIATHERMY "SAFE"?

In this method of treatment the tissues deep within the body can reach a very high temperature before the patient will realize it. This, incidentally, is a very interesting fact. That is, the deep organs of the body do not possess the special pain and heat receptors which are present in the skin. For example: the application of intense heat to the abdominal organs would elicit no pain. As for the soft tissues, like muscles and fat, they are not as acutely sensitive to variations in temperature of several degrees as are the superficial skin structures. Therefore, before the patient can advise the doctor of any apparent discomfort, his tissues may suffer a very severe, damaging burn. The doctor ordinarily has no way of knowing when a particular portion of the anatomy has been subjected to any certain amount of heat. The patient's reactions can be, usually, his only guide. This very pertinent point still requires much research in this newer field of electro-therapeutics.

Another danger, and by far a greater one, is the manufacture of these machines by persons not having the requisite knowledge of the electrical principles involved, and their therapeutic application. The trend of the medical profession towards the use of these machines has naturally invited the advent of charlatans in the field of manufacture, and in the field of medicine itself. Quack physicians will contemplate an easy dollar without the necessity of knowing too much, to the misfortune of the unwary patient.

A doctor is not supposed to be a radio or electrical technician and he depends entirely upon the integrity of the builder to supply him with a properly-designed apparatus which must perform PERFECTLY! The medical practitioner owes it to his patient to choose his machine carefully and wisely. He should inquire thoroughly into the technical background of the builders. A "cheap" machine may be all the word can imply and endanger his reputation.

In a subsequent article, the author will discuss at length the various types of modern diathermy machines, their relative merits therapeutically, and how they function.

THE RADIO MONTH IN REVIEW

(Continued from page 391)

more serious, the workmen were being burned by the energy stored up in the structure.

The difficulty was finally eliminated by erecting a temporary radiator for the station about a half-mile from the previous location. (Another way might have been to load up the tower under construction with sufficient inductance to ground so that the resonant frequency was far below that of the transmission frequency.—Editor)



You'll save time, trouble, and money, too—
WHEN YOU ORDER FROM YOUR ALLIED CATALOG!

"Time is money"—and you can't afford to waste it, hunting or waiting for that part you need—"prospecting" for low prices. That's why servicemen everywhere order from their ALLIED Catalogs—for ALLIED means faster shipment—lower prices—savings in time, trouble and money! ALLIED can fill all your radio needs—quickly, accurately and economically. Our huge stocks—the cream of quality radio, our central location—under one great roof, our closely knit organization—geared to meet your demands for "lightning" service, assure you of highest quality always—eliminate costly delays and inconveniences—you get what you want when you want it!

For faster service—satisfied customers, lower prices—bigger profits, order from your ALLIED Catalog!



TESTING LABORATORY AT ALLIED

A corner of our modern, well-equipped laboratory where skilled radio technicians carefully test ALLIED Radio equipment for quality and performance. Our high standards are your best protection—your assurance of greatest dependability and value!

EVERYTHING IN RADIO AT LOWEST PRICES

If you haven't a new 1937 ALLIED Catalog write now for your FREE copy! It includes more than 10,000 duplicate and replacement parts; 38 models of the new Knight Radios; dozens of Build-Your-Own kits; the latest SW receivers and transmitters; P.A. Equipment; test instruments; Rurlpower units and Windcharters; books, tools, etc. Send for this great book today!



ALLIED RADIO

ALLIED RADIO CORP. Dept. 2-A
 833 W. Jackson Blvd., Chicago, Ill.
 Rush me your 1937 ALLIED Radio Catalog.

CORPORATION

833 W. JACKSON BLVD. CHICAGO

Name

Address

City State

THERE'S A GOOD JOB FOR YOU IN RADIO
 We Will Train You Quickly to Qualify
 The servicing of modern radio receivers requires experts—men trained for this work are needed everywhere.

RADIO OFFERS BIG OPPORTUNITIES

Your possibilities of making money are limited only by your ability and skill. There is no room for the soldering iron "quesser." But you must be trained—the sooner you begin the quicker you'll cash in.

LEARN AT HOME

We will train you at home to service and repair radio receivers of all types. Invest for future success in R.T.A. training.

NO EXPERIENCE NEEDED

You need no previous experience in Radio. We show you how to make money almost from the start. Hundreds of men are enjoying the rewards of R.T.A. training.



FREE
 of extra cost

This time saving trouble-finder and circuit analyzer included.

Full details of this great opportunity are explained in a helpful book that is FREE. Send for it today. It will be mailed at once.

FREE

RADIO TRAINING ASS'N OF AMERICA
 Dept. RC-71, 4525 RAVENSWOOD AVE., CHICAGO

Please Say That You Saw It in RADIO-CRAFT

417

THINGS EVERY RADIO SERVICE MAN MUST KNOW

Ghirardi gives you all 417 in his remarkable MODERN RADIO SERVICING and handy FIELD DATA book—all clearly explained and illustrated. For instance—

How to use all kinds of test instruments. How they work. Complete construction data. Circuit diagrams. Latest models.

How to use the most successful modern methods in repairing receivers. "Case Histories" and time-saving, money-making short-cuts in service work.

How to align any make of superhet, and—

How to use the Cathode-Ray Oscilloscope method in alignment work.

How to track down and eliminate every type of noise and interference.

How to save time on all difficult troubleshooting and repair jobs. New dope on tests and remedies for hum, intermittent reception, distortion, etc.

How to install and service all makes of auto-radio receivers in all makes of cars and eliminate ignition interference.

How to master all the complexities of AVC and QAVC circuits and troubleshoot them.

These are but a few scattered items among the 417 essentials of modern radio servicing of which these books will give you easy mastery. Your shop is only half-equipped without them ORDER THEM TODAY. Money-back guarantee.

1300 PAGES 706 ILLUS.

MODERN RADIO

Servicing
\$4 alone
Together with 436 p

RADIO FIELD SERVICE DATA



\$6

MAIL TODAY!

TO: RADIO & TECHNICAL PUBL. CO., 45 Astor Place, New York, N. Y., Dept. RC-17

Enclosed find \$6 for combination offer, including Jan. & June '37 Subscribers to FIELD DATA book. Postpaid. (Foreign \$8.50)

Enclosed find \$1 for MODERN RADIO SERVICING alone. Postpaid. (Foreign \$1.50)

Please send free circular.

Name _____ Address _____

Also—RADIO PHYSICS COURSE—\$4

NEW TUBES FOR THE YEAR

(Continued from page 395)

the same results as the American 6L6 beam power tube, but in a slightly different way.

The inventor, J. H. Owen Harries, developed the device while experimenting with a tube having a flat plate which could be accurately moved with relation to the cathode and grid structure. Mr. Harries found that at a certain distance from the virtual cathode (space charge) the secondary emission from the plate is at a minimum. In other words, the plate saturation voltage does not increase with increase in the distance between cathode and plate, but there is a definite, critical point, greater than the usual plate-to-cathode spacing, at which the secondary radiation from the plate is at a minimum.

By application of this principle, Harries was able to develop a beam-type tube of the tetrode type, but having no suppressor-grid or even the deflector plates found in the American beam tube (see Fig. 2). The result of this elimination of the suppressor has permitted the design of a tube having the high power sensitivity of a pentode, but without the rounded "knee" in the plate-voltage—plate-current curve. It is well known that this rounded "anode bend" is the cause of the high harmonic content in the pentode-type tube.

Figure 3 shows a comparison of the plate-current—plate-voltage characteristic of the critical distance tube and (dotted) a comparative pentode output tube.

VARIABLE-MU ACORN PENTODE

The 956 Acorn, A tiny tube of particular interest to the short-wave radio man is the new acorn tube (Fig. B) just released by RCA. This tube, known as the 956, is a companion tube to the 954 pentode, having similar heater characteristics and physical size, but having variable-mu characteristics. This variable-mu characteristic makes the tube very effective in reducing cross-talk and modulation distortion. The tube may be used as an R.F. or I.F. amplifier, or as a mixer in receivers operating at wavelengths as low as 0.7-meter!

956 Characteristics

Heater Voltage (A.C. or D.C.)	6.3	V.
Heater Current	0.15	A.
Plate Voltage	250 max.	V.
Screen-grid Voltage	100 max.	V.
Control-grid Voltage (Minimum)	-3	V.
Suppressor-grid	Connected to Cathode	at socket
Plate Current	5.5	ma.
Screen-grid Current	1.8	ma.
Plate Resistance	0.8	Meg.
Amplification Factor	1,440	
Mutual Conductance	1,900	Micromhos
Mutual Conductance (At -45 V. bias)	2	Micromhos
Grid-Plate Capacity (with shield-baffle)	0.007 max.	mmf.
Input Capacity	2.7	mmf.
Output Capacity	3.5	mmf.

ULTRA HIGH-FREQUENCY OSCILLATOR

The 316A 0.4-Meter Transmitting Tube. The radio amateur and experimenter in ultra-high frequency equipment will be interested in the new W.E. type 316A tube which provides approximately 7.5 W. output at frequencies up to 750 megacycles (about 0.4-meter).

The tube is a direct-filament triode made without a base, to eliminate the capacity and losses associated with the insulation and parallel prongs at the very high frequencies (see Fig. C). For correct oscillation at the upper frequency limit of the tube it is necessary to provide tuning in the filament to ground circuit. The use of adjustable concentric lines of approx. 1/4-wave-length is probably the most satisfactory arrange-

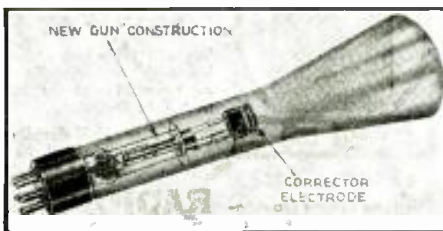

Fig. D. New C.R. tube with corrected images.

Please Say That You Saw It in RADIO-CRAFT

ment. The grid and plate leads should also be connected at node points, if possible.

316A Characteristics

Amplification factor	6.5
Plate resistance	2,700 ohms
Grid-to-plate transconductance	2,400 micromhos

Average Direct Interelectrode Capacities

Plate-to-grid	1.6 mmf.
Grid-to-filament	1.2 mmf.
Plate-to-filament	0.8 mmf.

Maximum Ratings

Max. direct plate voltage	450 V.
Max. direct plate current	80 ma.
Max. direct grid current	12 ma.
Max. plate dissipation	30 W.
Maximum plate voltage may be used at any frequency if maximum plate dissipation is not exceeded.	

R.F. Oscillator or Amplifier—Unmodulated

Max. direct plate voltage	450 V.
Max. direct plate current	80 ma.
Max. direct grid current	12 ma.
Nominal power output at 500 mc.	7.5 W.

Grid bias or leak should be adjusted to optimum value for the particular tube.

R.F. Oscillator or Amplifier—Plate Modulated

Max. direct plate voltage	400 V.
Max. direct plate current	80 ma.
Max. direct grid current	12 ma.
Nominal carrier power at 500 mc.	6.5 W.

Grid bias or leak should be adjusted to optimum value for the particular tube.

5-METER "BEAM" TRANSMITTING TUBE

The 807 5-Meter Transmitting Tube. The beam-type power tube which has raised such a furor in the audio amplifier and radio receiver circles has now invaded the short-wave transmitting field in the form of an R.F. power amplifier tube having ceramic base, top cap for low interelectrode capacity, and improved shielding to minimize the need for neutralization.

This tube, known as the 807 in the RCA line has a maximum plate dissipation of 21 W. and high power sensitivity. The latter characteristic makes it especially suited for use as a crystal oscillator, frequency doubler or buffer amplifier. Two 807s in class C for C.W. operation, will provide more than 50 W. output. The tube can be driven at the maximum ratings listed below on frequencies up to 60 mcs. (5 meters, approx.).

807 Characteristics

Heater voltage (A.C. or D.C.)	6.3	V.
Heater current	0.9	A.
Mutual Conductance, For plate cur. of 72 ma.	6,000	Micromhos
Direct Interelectrode Capacities:		
Grid-Plate (With external shielding.)	0.2 max.	mmf.
Input	11.6	mmf.
Output	5.6	mmf.

A.F. Power Amplifier and Modulator—Class AB₁

D.C. plate voltage	400 max. V.
D.C. screen-grid voltage	300 max. V.
Max.-signal D.C. plate current*	100 max. ma.
Max.-signal D.C. plate input*	40 max. W.
Plate dissipation*	21 max. W.
Screen-grid dissipation*	3.5 max. W.

*Averaged over any A.F. cycle.

R.F. Power Amplifier—Class B Telephony

(Carrier conditions per tube for use with a max. modulation factor of 1.0)

D.C. plate voltage	400 max. V.
D.C. screen-grid voltage	300 max. V.
D.C. plate current	80 max. ma.
Plate input	32 max. W.
Plate dissipation	21 max. W.
Screen-grid dissipation	2 max. W.

Plate-Modulated R.F. Power Amplifier—Class C Telephony

(Carrier conditions per tube for use with a max. modulation factor of 1.0)

D.C. plate voltage	325 max. V.
D.C. screen-grid voltage	250 max. V.
D.C. control-grid voltage	-200 max. V.
D.C. plate current	83 max. ma.
D.C. control-grid current	5 max. ma.
R.F. grid current	A.

Plate input	27 max. W.
Plate dissipation	14 max. W.
Screen-grid dissipation	2 max. W.

**R.F. Power Amplifier and Oscillator—
Class C Telegraphy**

Key-down conditions per tube without modulation**

D.C. plate voltage	400 max. V.
D.C. screen-grid voltage	300 max. V.
D.C. control-grid voltage	-200 max. V.
D.C. plate current	100 max. ma.
D.C. control-grid current	5 max. ma.
Plate input	40 max. W.
Plate dissipation	21 max. W.
Screen-grid dissipation	2 max. W.

Typical operation:

Heater voltage	6.3	6.3 V.
D.C. plate voltage	300	400 V.
D.C. screen-grid voltage	250	250 V.
D.C. control-grid voltage	-50	-50 V.
Peak R.F. grid voltage	80	80 V.
D.C. plate current	95	95 ma.
D.C. screen-grid current	10	9 ma.
D.C. control-grid current (approx.)	3	2.5 ma.
Driving power (approx.)	0.2	0.2 W.
Power Output (approx.)	17.5	25 W.

**Modulation essentially negative may be used if the positive peak of the A.F. envelope does not exceed 115 per cent of the carrier conditions.

NEW NON-DISTORTING OSCILLOSCOPE TUBE

The 34-XH Oscilloscope Tube. By means of several changes in the design and construction of their 3-in. type 34-XH tube the Allen B. Dumont Labs. has been able to effect two outstanding changes in the characteristics.

First, the addition of a corrector electrode, tied internally to the gun and changes in the shape of the gun itself combine to eliminate the "edge distortion" prevalent, up to this time, in all 3-in. tubes. The corrector electrode (a new term in oscilloscopy) is placed at the end of the deflector plates and serves to step up the speed of the cathode stream to the speed at the end of the gun, thus eliminating the retarding action of the deflectors.

Second, the correction of the image has also permitted increasing the sensitivity of the tube to just twice the sensitivity of previous types!

The combination of these two improvements has resulted in a vastly improved tube (Fig. D) in the popular 3-in. size.

INTERCHANGEABLE TUBE TYPES

The National Union Tube Corp. has just published a new tube book, listing 325 types of tubes with comparable types in new metal and metal-glass types compared to the old glass types, and new glass types compared to old. This book should be invaluable to experimenters and Service Men who are continually working with tubes in new and old receivers.

In this book, several tubes having similar characteristics to older tubes, but having new numbers, base connections, etc., which have not been mentioned in *Radio-Craft* before, are listed. They are re-listed, below.

TABLE I

New Type Number	Similar but not Interchangeable with
6D5	45
6D7	77
6E7	78
6J5G	76-6C5
6K5G	6F5
6Y5	84
6Z3	1V
6Z6MG	84
6U7G	6D6
6V7G	85
25B6G	43

*Names of manufacturers will be supplied upon receipt of a stamped and self-addressed envelope.

New! Announcing

the book 50,000 radio men have been waiting for!

RADIO BUSINESS

Promotion and Management

By **ALFRED A. GHIRARDI**
and **THEODORE S. RUGGLES**

It's new! It's unique! It's sensational! A treasure chest of field-tested business methods and sales promotion ideas. Tells you how to sell. How to advertise. How to get free publicity. How to start a business. How to run a radio store. How to do more business at a better profit. *Everything* you need to know about the business side of radio—a complete radio business course in one big book. The same ideas given to you here have made *thousands of dollars* for those who used them! Hundreds of practical and *successful* sales and advertising suggestions ready for you to put to work making money today. Copiously illustrated. Easy to read. *The only book of its kind!* Soon to be released. Send the coupon *today* for FREE circular.

★ **ADVERTISING** ★

Planning your promotional program. How much to spend. Costs. How to write your advertising. Tested appeals. Getting action. Preparation and production. Forms of advertising: — Display—Direct Mail — Newspaper — Broadcast—Phone Book — Other Media. Publicity. Merchandising. Premiums. Contests. Follow-ups. Etc.

Scores of examples of successful ads illustrated. Sales methods. Sales talks. Business Forms.

★ **SELLING** ★

Why people buy. Market analysis. Getting leads and prospects. Getting people into your store. Principles of selling. Store selling. Selling by phone. Outside selling —how to get by the door — following up leads. Selling talks. Sales resistances and how to break them down. Making business contacts. Etc.

Applies to radio sets, servicing, Auto Radio, P. A. work, accessories, appliances, etc.



★ **BUSINESS METHODS** ★
Setting up in business. Equipment. Store layout. Managing the business. Employee and customer relations. Financial data. Cost accounting. Sales and service forms and records. House policies. Etc.

CLIP and MAIL

Today Radio & Technical Publ. Co.

45 Astor Pl., New York Dept. RC-17

Please send free circular.

Name

Address

Free Circular

FOR DEALERS AND SERVICE MEN

TRIAD

THE QUALITY NAME IN RADIO TUBES

TRIAD MANUFACTURING CO., INC. PAWTUCKET, R. I.

DON'T MISS THE
ANNUAL BROADCAST
ISSUE
OF RADIO-CRAFT
NEXT MONTH!

Please Say That You Saw It in RADIO-CRAFT

TRIPLET

Pocket Volt-Ohm-Milliammeter

D.C. and A.C.

Size 3-1/16" x 5 3/4" x 2 1/4"



Model 666
DEALER PRICE **\$15⁰⁰**

Uses large 3" Sq. Triplett Instrument.

A.C.-D.C. Voltage Scales Read: 10-50-250-500-1000 at 1000 ohms per volt.

D.C. Milliampere Scale Reads: 1-10-50-250.

Ohms Scale Reads: Low 1/2-300, high 250,000.

Black Molded Case and Panel.

Low Loss Selector Switch.

Complete with Alligator Clips, Battery and Test Leads.

A complete instrument for all servicing needs. Can be used for all A.C.-D.C. voltage, current and resistance analyses.

Dealer Price \$15.00

LEATHER CARRYING CASE for Model 666

Model 669, supplied extra.

Very attractive. Of black, heavy leather with finished edges and strap.

**SEE YOUR JOBBER
WRITE FOR CATALOGUE**



The Triplett Electrical Instrument Co.
161 Harmon Ave., Bluffton, Ohio

Without obligation please send me
More information on Model 666. I am
also interested in

Name

Address

City State.....

HOW TO MAKE THE RADIO-CRAFT-1937 TELEVISION RECEIVER

(Continued from page 399)

so that it is a simple matter to adjust it for any of the American stations now operating on ultra-high frequencies.

It is interesting to note the recommendations of the RMA committee which recently submitted a list of suitable characteristics for television transmission in the U. S. to the Federal Communications Commission. These standards will probably be the basis of all transmissions.

TABLE I

RMA TELEVISION COMMITTEE'S RECOMMENDED STANDARDS

ITEM	RMA RECOMMENDED STANDARD
1. Frequency allocation	
Lower limit	42 mcs.
Upper limit	90 mcs.
An experimental band starting at	120 mcs.
2. Channel width	6 mcs.
3. Spacing between television and sound carriers	3.25 mcs. (approx.)
4. Relation of sound carrier to television carrier	Sound carrier higher in frequency
5. Polarity of transmission	Negative
6. Number of lines	440-450
7. Frame frequency	30 per second
Field frequency	60 per second, interlaced
8. Aspect ratio	4:3
9. Percentage of television signal devoted to synchronizing signals	Not less than 20%
10. Synchronizing signal	No recommendation*

*"Serrated" vertical signal favored by RCA. "Narrow" vertical signal favored by Philco, Hazeltine, Farnsworth, General Electric Co.

THE SET

So much for the conditions under which our set was made. We have painted a somewhat pessimistic picture of the situation so that those who seriously contemplate the construction of one of the sets will not be over-optimistic. Suffice to say that satisfactory images can be received under the conditions mentioned—and the construction of the set is well worth while!

In Part I we will cover the construction of the Image Channel usually called the "video" channel, as far as the 2nd-detector. In subsequent parts we will cover the accompanying Sound Channel and the optical equipment of cathode-ray tube, sweep oscillators and high-voltage power supply for the C.-R. tube.

The video channel we will use for the present as an efficient 5-meter superhet. receiver to pick up the sound accompaniment of the television signals, the sound of the signals themselves and those amateur phone stations which are situated adjacent to the television channels. (See Fig. 1.)

The set contains a new, 956 acorn variable-mu pentode similar in appearance to the 954 which is familiar to most radio men but having the advantage of remote cut-off. This tube acts as the 1st-detector. The oscillator is another acorn tube—this time a triode type 955. These two circuits are tuned by a 2-section condenser which is made from a type MC-35-MX (see List of Parts) by removing 3 rotor plates and 2 stators from each section. The inside plates on both sections are removed in order to leave the great-

est possible spacing between the two sections—to prevent interaction.

The 956 tube feeds into 2 stages of I.F. amplification using a new type of iron-core, air-condenser-tuned transformers which are tuned to 3,100 kc. The secondaries of these transformers are shunted by resistors, Rx, which are used to load the windings so that the required wide-frequency channel can be obtained. Further information will be given about these resistors later.

The second I.F. stage feeds into a type 6Q7 double-diode-triode tube which functions as the diode 2nd-detector and a phase-reversing and amplifying tube for the image synchronizing circuit. For the present use of the set (hearing "hams" and music) the output of the triode section of the tube is used to connect to headphones or loudspeaker.

Special design of the power supply is due to difficulty of filtering the power supply for a receiver having the wide-frequency range required for the reception of images. This power supply consists of a power transformer having an over-size core to produce good regulation. The high-voltage winding of this transformer is shunted by 2 mica condensers to remove any transient currents which might otherwise enter the receiver. The filter is also of special design consisting of 4 Aalloy Transformer Co. chokes used in conjunction with 4 Cornell-Dubilier electrolytic condensers. The reason why 4 chokes are used is to keep the distributed capacity of the windings at a minimum so that the filtering action will be at its maximum.

All the plate circuits and screen-grid circuits of the tubes are isolated and bypassed with mica condensers. This permits the greatest amplification per stage consistent with stable operation. The screen-grid of the 956 tube is connected to a potentiometer located under the chassis to adjust the voltage to the optimum point. Once this resistor is set it need not be changed unless the tube is replaced.

The volume of the video channel is controlled with a resistor in the cathode circuits of the two 6K7 I.F.-stage amplifiers.

CONSTRUCTION

The layout of parts of this unit is quite important and for this reason, a chassis drilling layout is shown in Fig. 2. It will be noticed that in the rear left side there is an open space. This space is reserved for the sound channel. The sound channel will consist of its own I.F. amplifier and 2nd-detector, and an A.F. amplifier. (This I.F. amplifier is tuned to a frequency removed from the video I.F. amplifier by the spacing between the video and sound channels of the station to be heard. However, we will describe the construction and operation of this sound channel in a subsequent part, in greater detail.)

The aerial and oscillator coils of the set are identical in construction. As shown in Fig. 3, they consist of 11 turns of No. 12 bare copper wire wound to a diameter of 1/2-in. and spaced so that the entire winding is 1 1/8 ins. long. These windings are self supporting and are mounted directly on the 2 sections of the tuning condenser. A flat strip extending between the 2 coils and fastened under the condenser mounting screw is used as the common return for the 2 coils. Also, it is a good idea to provide the tuning condenser with a soldered pigtail which is soldered to the same mounting screw and to the shaft of the condenser. This pigtail should be made of flexible wire—as short as possible—and soldered in such a position that it does not touch the condenser shaft as the condenser is rotated between maximum and minimum.

In wiring the 956 tube it will be found desirable to mount the tube "upside down" in other words, instead of the long end (plate) being on top, the short end (control-grid) is at the top. This permits the leads to the grid and plate to be kept as short and direct as possible. In making this reversal it must be remembered that the screen-grid and suppressor-grid contacts of the socket are reversed and must be wired in reverse.

In wiring the set it is desirable—especially in the 956 and 955 circuits—to return all bypass condensers, resistors and grounded leads to a single ground position on the chassis (one for each stage). An examination of the underside of the chassis in Fig. C. will show how this is done. The reason for this unusual wiring is to

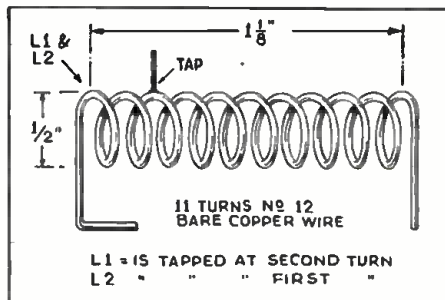

Fig. 3. Aerial and oscillator coils. L2 is spaced out to track when aligning.

Please Say That You Saw It in RADIO-CRAFT

keep the high-frequency currents localized as much as possible so that interaction between stages will be reduced to a minimum.

ADJUSTMENT

After the set has been completely wired and the wiring has been carefully checked the set is ready to align. The I.F. amplifier should first be adjusted to 3.100 kc. by means of a calibrated oscillator and pair of phones or some visual output indicator. For our present purpose, the I.F. amplifier is left with its natural band width and so this alignment is quite normal.

Next, the tuning condensers should be rotated slowly until a signal is heard and the oscillator plates should be carefully moved closer and further apart tusing care to prevent them from being broken loose from their supports) to determine the position for greatest volume. The ends of the rotary plates are then bent until the same volume is obtained. This procedure is then repeated for as many stations as possible over the entire band covered by the coils. Special care should be used in aligning the stations of the television transmitter and the transmitter which carries the accompanying sound. The characteristic sounds of the television transmitter will be recognized immediately.

Next, the screen-grid resistor of the 956 tube should be varied until the volume is strongest, without allowing the 1st-detector drop into oscillation. The cathode bias resistor on the front of the chassis can then be used to vary the volume to suit.

The video channel may then be used as much as desired, to get acquainted with the ultra-high frequencies with which we will be working in building and operating the remainder of our receiver.

LIST OF PARTS

- One Hammarlund type MC-35-MX dual condenser (changed as explained in text). C1, C6;
- Two Meissner Ferrocart Alignaire type 6239 3.100 kc. input I.F. transformers, IFT1, IFT2;
- One Meissner Ferrocart Alignaire type 6241 3.100 kc. output I.F. transformer, IFT3;
- Eleven Cornell-Dubilier mica condensers, 0.01-mf., C2 to C5, C8, and C10 to C15;
- Two Cornell-Dubilier mica condensers, 100 mmf., C7, C17;
- One Cornell-Dubilier mica condenser, 0.001-mf., C9;
- One Cornell-Dubilier mica condenser, 0.05-mf., C16;
- Two Cornell-Dubilier mica condensers, 0.002-mf., C18, C19;
- One Cornell-Dubilier electrolytic condenser, 4 mf., C20;
- Three Cornell-Dubilier electrolytic condensers, 8 mf., C21, C22 (2 in parallel);
- One Continental Carbon resistor, 200 ohms 1/2-W., R1;
- One Electrad potentiometer, 50,000 ohms, R2;
- Four Continental Carbon resistors, 0.1-meg. 1/2-W., R3, R8, R11, R17;
- Four Continental Carbon resistors, 10,000 ohms 1/2-W., R4, R6, R9, R12;
- Two Continental Carbon resistors, 50,000 ohms. 1/2-W., R5, R14;
- Two Continental Carbon resistors, 300 ohms. 1/2-W., R7, R10;
- One Electrad potentiometer, 4,000 ohms, R13;
- One Continental Carbon resistor, 0.5-meg., 1/2-W., R15;
- One Continental Carbon resistor, 3,000 ohms, 1/2-W., R16;
- One Alloy Transformer special transformer, type 621-1A, P.T.;
- Four Alloy Transformer 100 ma. filter chokes, type 797, Ch1, Ch2, Ch3, Ch4;
- *One type 302 vernier dial;
- Two Hammarlund acorn tube sockets, type S-900;
- Four Hammarlund octal tube sockets, type S-8;
- One RCA Radiotron type 956 acorn pentode tube, V1;
- One RCA Radiotron type 955 acorn triode tube, V2;
- Two Raytheon type 6K7 metal tubes, V3, V4;
- One Raytheon type 6Q7 metal tube, V5;
- One Raytheon type 5Z4 metal tube, V6;
- One Blan toggle switch, Sw.1;
- One Blan chassis 11 x 11 x 3 1/4 ins. deep;
- Four Blan octal-type grid clips;
- As needed, wire, terminals, etc.

*Names and addresses of manufacturers will be sent upon receipt of a stamped and self-addressed envelope.

CASH IN ON THE MOST SENSATIONAL TRAINING PLAN IN RADIO'S HISTORY



I Will Prove That 17c a Day

(Just About the Cost of a Pack of Cigarettes)

ACTUALLY SETS YOU UP FOR BUSINESS

RIGHT NOW! Is the Time to Get Started in an Industry that Is Making Fortunes for Live, Wide-Awake Men.

THIS new and different kind of Training does more than teach you about all branches of Radio. It teaches you Radio business methods—it sets you up ready for an actual start in business—and it backs up every step of your training with REAL PROFESSIONAL RADIO EQUIPMENT!

No matter what kind of Radio Training you take, it is absolutely necessary that you have equipment of this kind BEFORE you are ready to start making real money.

Sprayberry Training brings it to you almost at the start—teaches you just how to use it under actual working conditions. Upon completion you have COMPLETE business and technical training, PLUS the needed equipment to enter business at once for full or part time profits—or to start off on a career in any one of Radio's specialized fields, such as Public Address, Auto Radio, Commercial Radio, Broadcasting, etc.

READ WHAT OTHERS SAY ABOUT THE FAMOUS SPRAYBERRY TRAINING

A. H. LANOIE, Northbridge, Mass., writes: "Since enrolling I have cleared a net profit of more than \$150 in spare time alone . . . and I am not half through the course yet. Honestly, I cannot understand how you can give so much for so little money."

EDWIN A. GAMMON, Auburn, Me., says: "Due to your course I have been deluged with work . . . achieving good results with radios which had been unsuccessfully tackled by other servicemen. You deserve all the credit."

WALTER DAVIS, Baltimore, Md., enthuses: "Thanks to the Sprayberry Practical Course, I am now making on an average of from \$10 to \$25 per week in spare time work."

I CAN TEACH YOU QUICKLY—NO PREVIOUS EXPERIENCE REQUIRED

No matter what type of work you have been doing . . . no matter how limited your past experience in Radio . . . my practical, home study course will thoroughly fit you for a useful and profitable career.

You will be amazed at how quickly you will grasp the fundamentals of modern RADIO . . . it is really very easy to learn. My course has been planned to give you just what you need. It's easily understood . . . the best TRAINING value you will find anywhere in the country. Write today for my latest FREE booklet, "YOUR FUTURE IN RADIO."

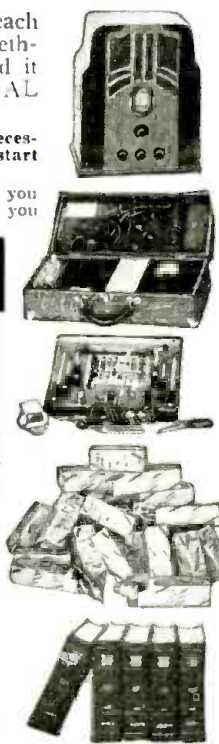

YOU GET THIS PROFESSIONAL EQUIPMENT

SERVICEMEN!

For those already in Radio, Sprayberry offers an **ADVANCED** Training Course that has proved invaluable to hundreds of servicemen. Saves you time — saves money — teaches you the easiest way to do the hardest jobs. Get details. Mark an X here () and we will send our **ADVANCED Radio Training Booklet** free.

SPRAYBERRY ACADEMY OF RADIO

F. L. Sprayberry, President
2545 University Place, N. W., Washington, D. C.

Without obligation on my part, please send your Free book, "YOUR FUTURE IN RADIO," and other details of famous Sprayberry Training.

Name
Address RC-37
PASTE COUPON ON PENNY POSTCARD AND MAIL TODAY.

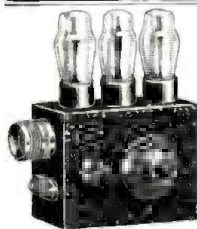

3-Tube Short Wave Radio
Only \$3.25
(less tubes, phones, unwired)

A REAL, powerful 3 tube short wave set that readily brings in amateurs, police calls, broadcast stations, experimental and foreign stations with good volume under fair conditions. **THE WORLD AT YOUR DOOR!**

THREE TUBE BATTERY SET, less tubes, phones, unwired \$2.95
TWO TUBE BATTERY SET, less tubes, phones, unwired \$2.00.

A dependable receiver which is guaranteed to give results entirely from the AC or DC house current. Simple to build and easy to operate. Beautiful, black shroud finish cabinet and instructions furnished. Wave-length range 12-600 meters. An ideal set for the beginner who wishes to learn the thrill of short wave reception.

KITS wired, extra 75c. Tubes, each 50c. Broadcast band coils (2), extra 95c. Cancellation, double headphones \$1.35.

BS-5 6-TUBE BAND SWITCH RECEIVER

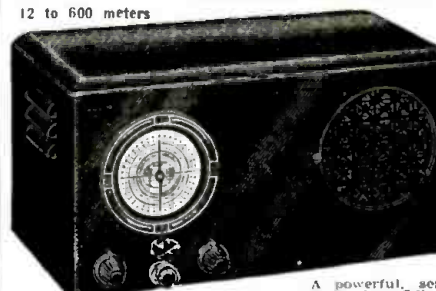

A powerful, sensitive, and selective SW receiver covering the entire wave-length span of 12 to 600 meters in 5 steps. No PLUG-IN COILS are used. Simply turn the waveband selector switch and enjoy reception on any wavelength within this range.

PRICE, complete with 6 tubes, cabinet, wired, ready to use **\$16.95**

BS-5 KIT, of necessary parts, including detailed instructions, less tubes, cabinet, unwired **\$10.95**

SPECIAL: Complete kit, cabinet, tubes and instructions, unwired **\$14.95**
(If metal tubes are preferred to Glass type, add \$1)

FREE: New 1937 Catalogue

24 hour service on all orders. 20% deposit required on C.O.D.'s.

EILEN RADIO LABORATORIES

Dept. RC-1, 136 Liberty Street, New York, N. Y.

Ill train YOU QUICKLY
for **Good FULL-TIME**
and **SPARE-TIME Jobs in**
ELECTRICITY



Get Into a Big Pay Field for a Big Pay Future
Train in your Spare Time
by **PRACTICAL Shop Methods**

WITHOUT LEAVING HOME

Now, Electric Institute brings—**TO YOUR VERY DOOR**—practical training necessary for the rich rewards in Electricity. Keep your present job—no need to leave home—now you learn **ELECTRICITY** easily, practically—**RIGHT AT HOME**—in your spare time.

Prepare for Jobs Leading to Salaries of \$30, \$40, \$50 a Week

Get into a real money making field for a big pay future. There is no better way to succeed than to **TRAIN** for work in an industry that is expanding. New Electrical projects constantly mean more jobs for men with practical training. Almost every industry uses **TRAINED ELECTRICAL MEN**. Or you can own and operate an electrical business of your own.

Opportunities to Earn Up to \$5, \$10 a Week or More While Training

With this amazingly easy, fascinating method of **HOME SHOP TRAINING** it is possible to start **EARNING MONEY** almost at once. Do not confuse E. I. Training with dry, theoretical text book courses. Electric Institute tells you exactly **WHAT to do—THEN YOU DO the ACTUAL JOBS** with **ELECTRICAL EQUIPMENT and APPARATUS** which comes with your training at no extra cost.

Become a **TRAINED** man without leaving home or your present job—then be ready to step into a **REAL ELECTRICAL JOB**.

Money Back If Not Satisfied

You must be satisfied. I give you an agreement to return every cent you pay on tuition if, after completing my training, you are not satisfied in every way with my instruction, equipment or other services given you.

With my training, my graduates receive life time consultation service, employment service and many other features to help them succeed in Electricity.

Electric Institute is ready to show you the way in the great, growing field of **ELECTRICITY**—where trained men are **ALWAYS NEEDED**. Mail coupon **TODAY**—for big, free book of facts about this revolutionary **Practical Home Shop Training** and the tremendous opportunities in **ELECTRICITY**.

DIESEL ELECTRIC POWER, RADIO and REFRIGERATION

Take advantage of the opportunities awaiting trained men in these and many other branches of Electricity, with **ELECTRIC INSTITUTE** practical training. Mail coupon for complete facts about **ELECTRIC INSTITUTE**—it may be the turning point in your life.

FREE
ELECTRICITY

RUSH the COUPON—TODAY—BIG BOOK FREE

H. W. Petersen, President
Electric Institute, Inc.,
Dept. 157A Hinsdale, Illinois
Send Free Book with all facts about E. I. Home Shop Training.

Name.....Age.....
Address.....
City.....State.....

BUILD THIS 12- TO 500-METER "BANDSWITCH 5"

(Continued from page 406)

coupled into the control-grid winding of the detector stage, the proper windings for the wavelength in question being selected by the band-switch Sw.1. This switch is one having an extremely low distributed capacity and a very high R.F. impedance in order to reduce losses to an absolute minimum. Electron coupling, due to its high order of sensitivity, selectivity, and smooth operation, is used in the oscillator system. The cathode taps on the 5 coils have been carefully worked out in order to insure maximum sensitivity and ease of control.

Regeneration is controlled by means of potentiometer R10 (0.1-meg.) having a specially-tapered resistance characteristic. This method of oscillation control has no effect on the tuning adjustments. The A.F. component of the output of the detector stage is fed into the 2-stage A.F. adjustments.

The approximate wavelength coverages of the 5 steps are as follows: 12 to 26; 25 to 50; 48 to 90; 88 to 204; and 202 to 550 meters. Operated from any aerial having an overall length of from 20 to 90 ft., this receiver is capable of consistent foreign as well as domestic short-wave reception at full loudspeaker strength.

LIST OF PARTS

- One Eilen special chassis and cabinet, drilled for use;
- *One illuminated vernier airplane dial;
- One Oxford Premier 5-in. dynamic speaker with transformer;
- One Hammarlund tuning condenser, 140 mmf., C5;
- One Hammarlund bandsread condenser, 15 mmf., C6;
- *One headphone jack, J;
- *One 5-prong glass tube socket;
- *Four 6-prong glass tube sockets;
- *One 7-prong metal tube socket;
- One Eilen set of 5 special coils;
- *One resistor, 50,000 ohms, 1/2-W., R1;
- *One resistor, 2 meg., 1/2-W., R3;
- *Two resistors, 500 ohms, 1/2-W., R2, R8;
- *One resistor, 0.15-meg., 1/2-W., R4;
- *Two resistors, 0.25-meg., 1/2-W., R5, R9;
- *One resistor, 2,500 ohms, 1/2-W., R6;
- *One resistor, 0.1-meg., 1/2-W., R7;
- One Centralab regeneration control, with switch, 0.1-meg., R10;
- *One switch, 2-pole 5-throw, Sw. 1;
- One Cornell-Dubilier mica condenser, 250 mmf., C7;
- Two Cornell-Dubilier mica condensers, 100 mmf., C1, C4;
- Four Cornell-Dubilier tubular condensers, 0.01-mf., 400 V., C2, C3, C8, C9;
- Two Cornell-Dubilier tubular condensers, 0.1-mf., 400 V., C11, C12;
- One Cornell-Dubilier dual filter condenser, 30 mf., 175 V., 10 mf., 35 V., C10;
- One set RCA tubes;
- *One octal-base resistor tube, type K49A, V6;
- *Four black bakelite knobs;
- Fifteen ft. black push-back wire, solder, hardware;
- One Kenyon filter choke, ch.

- *Names of manufacturers will be supplied upon receipt of a stamped and self-addressed envelope.
- This article has been prepared from data supplied by courtesy of Eilen Radio Laboratories.

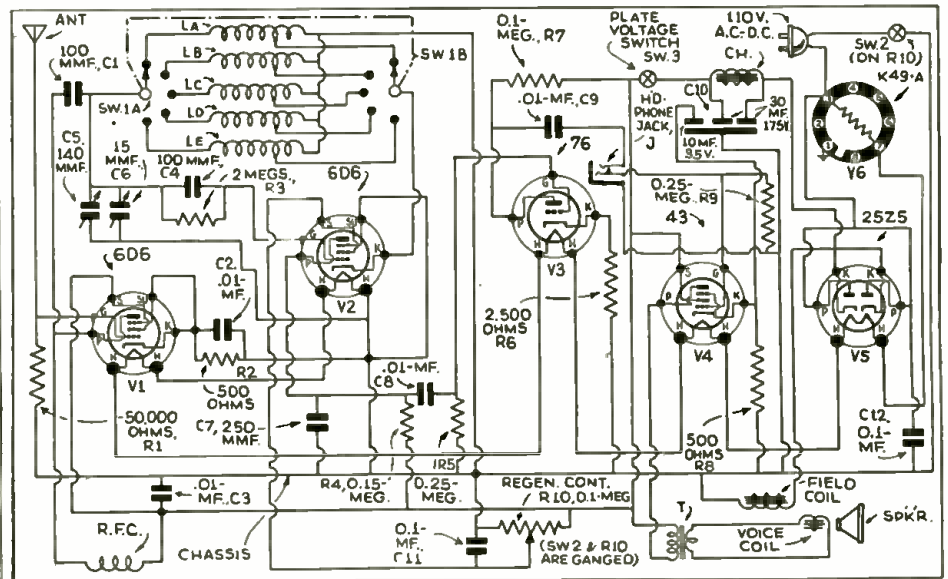

The circuit of the 5-tube set. The line dropping resistor looks like a "metal tube."

GRIDLESS VS. GRID TUBES

(Continued from page 397)

distortions caused by these electrode currents.

(6) Inherent ability to limit either their own output current automatically, within any fixed range of variations, or unwanted signal or noise amplitudes, either below or above a given intensity level, as determined by adjustable electrical circuit constants—thus producing an "anti-noise" tube!

(7) Possibility of modulating several electron beams similarly and simultaneously, or else differently and independently, as desired to utilize their various outputs for a common purpose or for individual and different purposes.

(8) Production of (relatively) very short electron beams of the full and complete cathode electronic emission, without resorting to the use of so-called "electron gun" or other electrical means well-known to the art (which, however, are unable to cause the utilization of the full cathode emission).

(9) Possibility to cause purposely the liberation of secondary electrons, by coating certain

electrodes with appropriate rare earth oxides; and to utilize the secondary emission produced by primary electron impacts thereon to obtain a higher voltage and/or current amplification.

(10) Another new and advantageous feature (available in one design) is a novel type of controlling electrode, shaped and positioned in such a manner as to divide an electronic emission, radiating uniformly around a cathode, into a number of electron beams; while exerting electrostatic pressure upon all these beams simultaneously or independently.

There are many more features and advantages to be found in the radically-new "gridless" principle of operation, and tubes that, by means of "compressor" electrodes, utilize this principle of operation; but space does not permit further elucidation at the moment. However, the writer will be glad to answer any inquiries, concerning the gridless tube, if these inquiries (addressed in care of *Radio-Craft*) are accompanied by a stamped and return-addressed envelope.

Please Say That You Saw It in **RADIO-CRAFT**

LOOKING AHEAD IN THE RADIO FIELD

(Continued from page 405)

communication system.

Radio men who have taken courses in broadcast technique will be interested in Mr. McNary's suggestion that the present broadcast band be extended to the frequency limits of 520 kc. (consequently adding 3 channels) and 1,600 kc. (adding 5 channels), thus in the latter instance absorbing existing experimental television frequencies. The repercussion was immediate. Purdue University pointed out that they had found the 1,600 kc. region of frequencies to be particularly satisfactory for long-distance television, even up to 1,000 miles. National Television seconded the idea that this portion of the radio spectrum be retained for television. And at the other end of the scale, Mackay Radio and Uncle Sam pointed out, is the 500 kc. channel reserved for the SOS distress call, thus endangered.

The experimenter in radio must keep in mind the very important phenomena of diurnal variations. If he is interested in long-distance or international radio services, we learn from remarks by Dr. C. B. Jolliffe, former FCC Chief Engineer and now with RCA Communications, Inc. ("RCAC"). Addressing the Commission, the Doctor pointed out that RCAC provides direct radio contact between the United States and 47 nations, and between 11 cities within the United States, but that this service is possible only by dependence on the assignment of numerous radio frequencies. Due to variations in reflection and refraction of radio waves, depending upon the time of day or night, the time of the year, and other factors, reliable communication is possible only by utilizing to the full the distance-bridging possibilities of particular frequency ranges for specific needs. Realization of this important fact immediately reveals the need for numerous frequency assignments; however, each of these frequency ranges now available to RCAC are utilized insofar as possible if not for one or another service, so that maximum economy may be exercised in the use of the precious allotments.

Sound recording received a boost the other day when a New York newspaper ran an editorial comment headed "Huey Long Will 'Speak' Again." The editorial pointed out that the "voice" was scheduled to be reproduced at the N. Y. Hippodrome from one of ex-Senator Huey Long's recorded radio speeches. Sound recording received more attention when Senator Vandenberg's controversial "debate" with the reproduced voice of President Roosevelt originally recorded in 1932 was refused time on the air by many broadcast stations last October. And sound recording for the third time received publicity in the press when later Colonel Knox announced that he would use the Senator's "debate" record to preface some of his political speeches over the P. A. system in his special train (equipped with sound-reproducing apparatus)! Technical men in every branch of radio had a finger in the "pie" of expenditures for various political radio activities (broadcasting public address etc.) that ran into hundreds of thousands of dollars, last November.

A newspaper report states that Benny Rubin keeps his youngster (3,000 miles away in Hollywood) posted on his broadcasts by making records of them including special interpolations and sending them to the boy. Another broadcaster Erling C. Olsen telephones his nightly 5-minute script when the stock market closes to a local New York studio; this enables him to catch the 6:15 for his home in Scarsdale in time for supper and to hear his program over WMCA.

Lieutenant E. K. Jeff, FCC Assist. Engineer, explained that "There is no reliable information available as to the amount of activity on frequencies above 110 megacycles." It was for this reason, therefore, that the Commission in 1931 decided to stimulate investigation of these ultrahigh frequencies, and gave permission to the licensees of all classes of stations in the experimental service, including amateurs, to operate (in their particular classes) on any frequency above 100 megacycles they cared to select, without further authority.

Free!

CLOUGH-BREngle INSTRUMENTS

new 1937 MODELS with NATIONAL UNION TUBES

FLASH! EXTRA!

Time Payments on Deposits!!

Service experts! Get many latest type service instruments for only a few dollars down and time payments on the initial low N.U. deposit. Remember—deposits are refunded when tube purchases are complete! Get the equipment you need, get it now, the sensational new N.U. way. See your jobber for details!



1937 Clough-Brengle Signal Generators. Model OMA operates from 110 volts, 50-60 cycle, continuously variable 100 K.C. to 30 M.C. Single and double trace selectivity. Curves for use with output meter or oscillograph; Complete with tubes and accessories. Model OC-A, 100 K.C. to 30 M.C., operates from 110 volts, 50-60 cycle. Complete with tubes and hand drawn calibration curves. Available on N.U. tube deals with time payment plan covering deposit. Investigate.



MODEL OMA
14c PER DAY
\$11.40 DOWN
DEPOSIT REFUNDED

YES—FREE—THE N. U. WAY

The National Union Way makes the purchase of National Union radio tubes doubly profitable. Besides full protection on the highest quality radio tubes, each National Union tube purchased helps to earn free equipment. But, possession of the equipment is obtained at once with just a nominal cash deposit. (Deposit is rebated when required number of tubes have been purchased.) Over 50,000 completed deals with progressive radio dealers. Don't be misled. See your National Union jobber and get all the facts.



MODEL OC-A
7c PER DAY
\$5.40 DOWN
Deposit Refunded

Other National Union Offers

In SOUND EQUIPMENT Items available include 17-watt portable system, 10-watt portable system, 6-watt portable system, phonograph pickup and turntable, etc., all manufactured by Webster-Chicago.

In SHOP EQUIPMENT Items available include stock cabinets, display signs, etc. All items absolutely free the National Union Way. Get full details.

In SERVICE EQUIPMENT Items available include tube testers, analyzers, oscillographs, signal generators, modulators, meters, etc., products of such manufacturers as Supreme, Clough-Brengle, Hickok, Triplett, Readrite, Precision, Radio City, Dumont, J.F.D., and others.

About National Union Radio Tubes

National Union manufactures a complete line of radio tubes in glass, metal and G-type. National Union's high quality has made them the outstanding favorite in the radio service profession. All sales policies have been formulated with the idea of making National Union radio tubes the ideal replacement tube for the radio dealer. This has been backed up with a selling program that means real support and help to the wide-awake dealer. Dealers and jobbers handling National Union radio tubes are the leaders in repair parts and service.

Let National Union Help You Write for Information

NATIONAL UNION RADIO CORPORATION
570 Lexington Ave., New York City RC137
Without obligation please send me more information on
.....Free offer on Clough-Brengle Model OMA
.....; Model OC-A.....
.....Free offer on.....
Dealer's Name
Address
City State

WHAT TO MAKE and how to make it ON A LATHE

WRITE for these books: (1) The Home Workshop, free; (2) What to Make on the Lathe, 10c; (3) How to Run a Lathe, 100 pages, 25c. Coin or stamps accepted. Any South Bend Screw Cutting Lathe on easy terms. Priced \$75 up. Ask for Catalog 15, free.

SOUTH BEND LATHE WORKS
536 Madison St., South Bend, Indiana, U.S.A.

RADIOS WHOLESALE! 30 DAYS TRIAL

5 TUBE \$6.95

Tune in on politics, news, music, market and weather reports with a new ZEPHYR WORLD-WIDE RADIO. All the latest improvements. MONEY-BACK GUARANTEE. One Year FREE service.

All electric, farm, battery and auto radios. Buy direct and SAVE UP TO 50%. Ask about our User-Agent Plan EARN EXTRA MONEY, be a ZEPHYR sales-man.

Write for FREE Illustrated Catalogue

ZEPHYR RADIO CO.
13141 Hamilton Ave., Detroit, Michigan.

Please Say That You Saw It in RADIO-CRAFT



The Right Combination at Your Fingertips

Here's some light on that SELECTOR SWITCH PROBLEM, you Knight of the soldering iron.

If the circuit calls for more lugs than a centipede has feet, scam over to your jobber, and make up your own SELECTOR SWITCH . . . thousands of different combinations possible with a CENTRALAB Kit at his place.

- Switches for:
- Analyzers
 - Output meters
 - R. F. Oscillators
 - A. F. Oscillators
 - Tube Checkers
 - Decade Boxes
 - Capacitance
 - Resistance
 - Ham Equipment
 - P. A. Work
 - Volt-Ohm-Ammeter
 - Radio Receiver Replacements



Centralab

MILWAUKEE WIS.

BRITISH CENTRALAB, LTD.
Canterbury Rd., Kilbourn
London N.W. 6, England

CENTRALAB
118 Avenue Ledru-Rollin
Paris XI, France

300% INCREASE in 2 YEARS!

THE MOST COMPLETE LINE—ALL TYPES OF GLASS, OCTAL BASE. METAL AND AMATEUR TRANSMITTER TUBES

NEW Du Mont TUBE SPURS TELEVISION

A SENSATIONAL advancement in Television has been made possible by a new type Cathode Ray tube perfected by Allen B. Du Mont Laboratories, Inc. Experimenters, service experts and engineers are invited to write to Allen B. Du Mont Laboratories, Inc., Upper Montclair, N. J. for information on the new tube. It is also suggested that those interested in television receiver construction follow the series of articles on this subject, starting in this issue of Radio-Craft.—Advt.

A SIMPLIFIED CONVERTER FOR THE SHORT-WAVE RADIO BEGINNER

(Continued from page 401)

lead must not pick up broadcast signals, and shielding must necessarily be very effective. Further, the cable should be of true low-capacity type to minimize signal loss.)

CONSTRUCTION

The chassis pan should be high enough for installation of the coil switch; drill and cut it (Fig. 2). If the dial specified is to be used the front cut-out will be necessary unless the builder is prepared for longer coil-condenser leads than those shown. The dial, of course, may be set up high, and supported by small angle brackets fastened both to the dial frame and the chassis—if so, the condenser must be raised. Or the dial may be brought forward; but this makes the control shaft protrude farther, and requires extensions for all other controls.

It might be wise to punch tube holes with a special die (for the retainer-ring-mounted sockets) unless regular laminated, but less efficient, sockets are used.

Mount the sockets, positioning them for shortest possible leads to associated components, and make sure that the retainer rings hold them firmly in place. Mount all other parts except coils.

Wire the filaments in series; follow the schematic carefully, and use fairly heavy, well-insulated cable. Wire up the power circuit; test for filament continuity and for shorts to ground. If an A.C. meter is available, put in all tubes, plug in the A.C. cord on the line, and get an over-all filament reading. This should be approximately 44 V.

The 3-wire line cord should have a self-contained resistor of 250 ohms unless the dial is to be pilot-lighted. If one pilot is to be used (6.3 V.), install a resistor cord (210 to 220 ohms value); add a 30- or 40-ohm power resistor to the series filament circuit, and wire the pilot in parallel with this power resistor. If 2 pilots are found necessary to light the dial scale, use a resistor cord of about 170 ohms value, with two 40-ohm power resistors in series in the filament circuit, and parallel a pilot light across each one of these. Pilots will probably not receive full voltage, but proper illumination for A.C.-D.C. dials, without burn-out when the set is plugged into the line, isn't easy; compromise is necessary (see Fig. 4).

Wire in all other parts which have been installed. Add tie points, supports soldered to the chassis, wherever they may seem necessary. Be sure to have one near the band switch, so that the return leads of coils may find secure anchorage. Bring a lead from the condenser rotors through the chassis to a short, direct, soldered ground, and then connect bypass condensers from the oscillator and detector coil ground-return tie points to this same ground point. Do not fail to bypass these coil terminals here. If one terminal is used for returns of both oscillator and detector coils, one bypass alone will be needed. But don't forget it, even if "B-" is

bypassed elsewhere; the complete high-frequency circuits MUST be localized properly.

If you haven't done it before, you must now do some work on the I.F. coils before these are finally installed. Remove the shield cans, carefully unsolder the leads to the trimmer condensers, and then unwind from each coil (4 in all—2 primaries, 2 secondaries) approximately 60 turns. It will now be necessary to carefully clean the wire of its insulating enamel, and resolder to the trimmer terminals. *Every care should be exercised in doing this.* The wire is stranded, and each and every strand must be cleaned and soldered. If strands are left unconnected, coil resistance may be appreciably increased, with poor performance a result. Test each coil for continuity; then get a resistance reading. The resistance for each coil should measure around 12 ohms.

Replace the cans, mount the coils, and wire the 2 I.F. components into the receiver. (Red wires to "B+," blue wires to plates, green wires to grids and output ground, black wires to "B-" and output connection to the D.P.D.T. switch.)

It might be wise at this point to go over the whole job now for continuity, shorts, etc. This should be done with tubes in their sockets, as there may be contacts between elements in some of the tubes.

COIL ADJUSTMENT

However much the coils may track on paper, it will be found that alignment difficulties, even with variable trimmers and padders, will be experienced on actual construction and application. Build and install one set of coils at a time, removing turns from both oscillator and detector units (or adding turns) until both I.F. limit alignment and desired H.F. limit "spotting" are had. If the detector circuit oscillates, connect the cathode to a lower point on the coil. If the 6C5 circuit does not oscillate, run the cathode tap up higher on the oscillator coil—selecting a final adjustment which will assure a fairly strong and uniform R.F. for injection into the 6L7's No. 3 grid. Antenna connection loading may throw off H.F. limit tracking, but the variable detector-circuit trimmer should permit easy compensating adjustment. If detector tuning has a frequency "pulling" effect on the oscillator, provide better shielding between coils.

The single "broad-band" coil set, or the H.F. range coils in a multi-band assembly, may be installed beneath the chassis, oscillator and detector coils at right-angles to each other and so positioned that a small shield partition may be placed between them. Leads of such coils should be short and direct to the band switch. The L.F. coils may be placed above the chassis, with detector units between the variable condenser and the tubes, and oscillator units on the other side of the variable. Plenty of space is available for mounting above the chassis but, though the under-chassis layout has been designed to give as much space as possible for coils, every care should be exercised in positioning them. Keeping them near the switch for short leads, yet placing them so that other coils and components will be out of their fields, won't be the easiest business in the world. And that's another reason why as few coils as possible should be employed.

PERFORMANCE

The laboratory model pictured was first built up with 3 sets of coils, covering a tuning range approximately from 12 to 200 meters. Performance was excellent, with the converter feeding a superheterodyne, with estimated sensitivity of about 5 microvolts for 50 milliwatt output. With the converter output fed into a far less sensitive T.R.F. job, of somewhat antiquated design, efficiency was, of course, lower but results warranted the addition of the converter unit to this receiver to give consistent reception of European short-wave broadcasts on the Pacific Coast.

All coils were then removed, except detector and oscillator units designed for medium-range coverage. The efficiency was found improved, with the I.F. limit extended. After careful readjustment of coil spacing and trimmers, a coverage from about 19 to 60 meters was obtained and, as this range hit most important S.-W. broadcast bands, we decided to return none of the other coils to the circuit. Eventually we

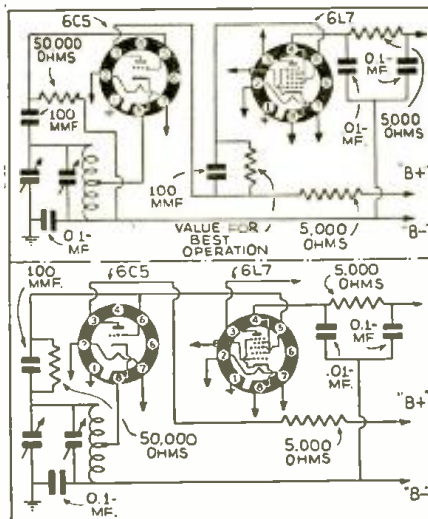

Fig. 3. Optional converter circuits.

Please Say That You Saw It in RADIO-CRAFT

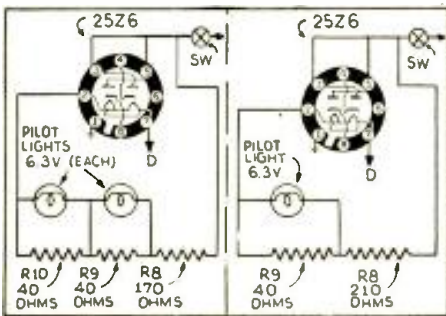

Fig. 4. Circuits for pilot light circuits.

shall take out the now unnecessary band switch; substitute a variable condenser with higher maximum rating than that now used; reduce the number of turns on the coils to permit 13-meter coverage, and wire the remade coils directly into the circuit. See a forthcoming issue of *Radio-Craft* for detailed data on coil "make-your-own" procedure.

Optional mixer circuits are shown in Fig. 3.

LIST OF PARTS

- One Meissner I.F. transformer, type 5712, 456 kc. (60 T. removed from each winding), I.F.T.1;
- One Meissner I.F. transformer, type 5714, 456 kc. (60 T. removed from each winding), I.F.T.2;
- One A.C.-D.C. midget choke, app. 400 ohms resistance, ch.;
- *One D.P.D.T. jack switch, type 60, Sw.1;
- *One S.P.S.T. rotary line switch, Sw.2;
- Two 2-gang low-minimum variable condensers, closing right, trimmers removed, max. capacity 360 to 420 mmf., C1, C2;
- One Hammarlund Star midget variable condenser, 50 mmf., C4;
- Eight Aerovox condensers, type 284, 0.1-mf., C3, C5, C7, C8, C9, C13, C14, C15;
- One Aerovox condenser, type 284, 0.01-mf., C6;
- One semi-variable trimmer, 3 to 25 mmf. or smaller, one for each oscillator coil, C10;
- One Aerovox condenser, type 1468, 100 mmf., C11;
- One Aerovox condenser, type 1468, 50 mmf., C12;
- Two Aerovox dual electrolytic condensers, type PBS 2, 8-8 or 8-16 mf., C16, C17;
- Two Aerovox dual optional condensers, type PBS 2, 4-4 or 8-8 mf., C18, C19;
- One Aerovox condenser, type 484, 0.1-mf., C20;
- One padder condenser, one for each wide-range or medium-frequency oscillator coil. (To consist of Aerovox type 1467 mica pad, 500 mmf. to .005-mf., paralleled with variable trimmer of widest possible capacity range, total capacity to be variable approximately 20 per cent of estimated required value), Padder Capacity;
- One Continental resistor, 600 ohms, 1 or 1/2-W., R1;
- One Continental resistor, 5,000 ohms, 1/2-W., R2;
- One Continental resistor, 5,000 ohms, 1/2-W., R6;
- Two Continental resistors, 50,000 ohms 1/2-W., R4, R5;
- One Continental resistor, 400 ohms, 1 or 1/2-W., R7;
- One line cord, 250 ohms, R8 (or, R8A, 210 ohms); R8B, 170 ohms—see text; then, two Electrad vitreous resistors, 10 W., 40 ohms, R9, R10—not shown in Fig. 1);
- One Electrad potentiometer, type 997 or 202, R3;
- One Centralab 3-gang, 6-circuit band switch, number points to suit;
- *One Micromaster dial, type 318;
- *One pointer knob, type 588;
- Four small round knobs;
- *One 2-ft. length low-capacity shield tubing;
- *One 25-ft. coil special R.F. wire for grid circuits and coils;
- One Blau aluminum, steel or electralloy chassis, 6 x 10 x 2 1/4 ins. high;
- *Two stentite low-loss octal sockets, type RSS (for V1, V2);
- *Two octal moulded sockets, type S8 (for V3, V4);
- One National Union or Raytheon type 6C5 metal tube, V1;
- One National Union or Raytheon type 6L7 metal tube, V2;
- One National Union or Raytheon type 6K7 metal tube, V3;
- One National Union or Raytheon type 25Z6 metal tube, V4.

*Names of manufacturers will be sent upon receipt of a stamped self-addressed envelope.

**Are You a Radio Connoisseur?
IF SO
"BE WISE AND KENYONIZE"**



AFTER two years of extensive research we are proud to introduce our new "T" components which are the most complete and up-to-date transformers ever offered—advanced in design, economical, efficient and completely reliable. This line is designed to satisfy the demand for a quality product for P. A. work and amateur transmitter use at a new low price.

NEW EXCLUSIVE KENYON FEATURES:

Adaptability to all needs is provided by the new durable black egg-shell finish case that permits top or bottom mounting!

INPUT TRANSFORMERS

Multiple line input transformers provide perfect coupling for single and double button microphones! These transformers are provided with hum cancellation windings which permit mounting them on the chassis of high gain amplifiers!

COMBINATION PLATE AND FILAMENT TRANSFORMERS

An electrostatic shield is incorporated between the primary and secondary of plate and filament transformers for P. A. and low power transmitters.

OUTPUT TRANSFORMERS

All output transformers for P. A. applications include 500 and 200 ohm windings for matching transformers, and windings of 15, 8 and 4 ohms for speaker voice coils!

FILAMENT TRANSFORMERS

A large variety of simple and multiple filament transformers provide filament supply for all types of tube combinations.

MODULATION TRANSFORMERS

Modulation output transformers for transmitters are provided with tapped secondaries which adequately carry the full Class "C" current load without saturation!

PLATE TRANSFORMERS

Kenyon plate transformers are designed to meet the rigid requirements imposed in amateur service. Many of these units incorporate the exclusive Kenyon triple and dual windings.

Ask your local dealer for a free copy of the first issue of the new 16 page monthly magazine "THE KENYON ENGINEERING NEWS." Also our new "T" line catalog.

Our new transmitting manual contains complete up-to-date transmitter circuits ranging in size from five watts to one kilowatt. Ten pages are entirely devoted to full page "Ken-O-Grafs" which cover most of the calculations used in radio in a modern and painless method. This book is no substitute for a catalog. To receive your copy send 25 cents in coin or stamps.

Address your inquiries to Chief Engineer, P. A. Division

KENYON TRANSFORMER CO., INC.
846 Barry St. New York, N. Y.

OUTSTANDING VALUE!

Model T-37 SIGNAL GENERATOR

The fastest selling Signal Generator on the market. You can't help but recommend it. Hundreds sold since its introduction six months ago.



Complete . . . only **\$12⁴⁰**

- 110 Volts A.C. or D.C.
- 100 kc.—22 megacycles all on fundamentals.
- Dial is direct reading in frequencies.
- R.F. output may be taken from a high impedance or a low impedance port, in with attenuation present for either.
- Separate audio output at 2 amplitude levels, so that tone may be used for checking public address systems, audio amplifiers in receivers, and speech amplifier in transmitters.
- Two extra posts on front panel enable leakage tests. Condensers may be checked for leakage, so may tubes, and other normally high resistance currents, otherwise difficult to test.

Model T-37 All-Wave Signal Generator, wired in shielded cabinet with carrying handle and calibrated; complete with 2 Tubes & Neon Tube, **\$12.40** instructions (shipping weight 7 lbs.)

SUPERIOR INSTRUMENTS COMPANY, 139 CEDAR STREET, NEW YORK, N. Y., Dept. T-A.

Please Say That You Saw It in RADIO-CRAFT

THE KING OF ALL INSTRUMENTS . . . BUILD IT YOURSELF!

YOU WILL LEARN MORE ABOUT RADIO AND ELECTRICITY, BESIDES UNDERSTANDING THE DESIGN AND APPLICATIONS OF THIS UNIT MORE THOROUGHLY. FULL INSTRUCTIONS SUPPLIED.

The Model "DL" Oscilloscope will not only permit accurate visual alignment of all types of receivers, but can be applied for visual investigations of all electrical phenomena as well as any type of measurement possible with this instrument. You can check and see clearly on the screen of the 3" Cathode-ray tube phase-shift, wave-form, percentage-modulation, selectivity, gain, output, distortion, etc. etc. By constructing this instrument in your spare time—not only do you save money, but, you learn more about the design and possible applications of the oscilloscope. Designed to remove all construction headaches, and engineered to insure a perfectly professional instrument.

PARAGON RADIO PRODUCTS,



COMPLETE OSCILLOSCOPE KIT

ONLY **\$28.50**
less Tubes

Every essential part is supplied with the kit, excepting tubes! The case is finished cracked black, and includes an adjustable leather handle as well as four felt padded feet. The panel is handsomely etched and looks as good as the most professional complete instrument. All controls are on the front panel, including the spot-adjusting controls. Tip-jacks are employed for input terminals. Vertical and horizontal amplifier stages, with controls for each. Timing Oscillator included, with calibrated 9 step control as well as image locking control. Cornell-Dubilier condensers, laboratory checked resistors and all other parts of finest quality. Write for free complete specifications and prices for individual parts or tubes.

136 Liberty Street, NEW YORK CITY

ELECTRICAL BOOKS
shipped FREE

10 BIG BOOKS

A-C-RADIO TELEVISION
EVERY ELECTRICAL SUBJECT COVERED

Here's great news for anybody interested in Electricity. BRAND NEW edition of Applied Electricity brought right down to date with every NEW Electrical subject fully covered. 10 big Volumes and all shipped FREE for examination. See special offer below.

BIG FIELD! Big Demand! Big Pay! Men who understand electricity are urgently needed right now in thousands of industries. Autos, airplanes, machine shops—practically every industry depends on electricity and men who know this subject make big money. Pleasant, fascinating work, easy to learn and do. Send coupon for a set of these books for FREE examination.

FREE S. Cernusack's famous Radio Encyclopedia (latest edition) given free with these electrical books if you send NOW. Invaluable in any Radio work. Covers whole Radio field.

American Technical Society, Dept. at 58th St., Dept. E 128, Chicago
Send for 10 days' free use, BRAND NEW 10 volume set of Electrical Engineering. Include free membership in the American Technical Society and S. Cernusack's Encyclopedia. I will pay the few cents delivery charges on the books. If I wish I may return them in 10 days and owe you nothing, but if I keep them I will send \$2.00 after 10 days, then \$3.00 a month until the special price of only \$20.00 is paid.

Name

Address

City

State

Attach letter stating nice, convenient and name and address of employer, and at least one business man as reference.

Make Winter Money

And Satisfied Customers with **NORWEST STREAMLINE AUTO ANTENNA**

Old man winter is pretty tough on most undercar antennas. Make real money this winter installing and replacing with Norwest. Especially designed for turret top cars. No holes to drill. Mounts on rubber vacuum cup standoffs. Adds to streamline appearance. Low motor noise level obtained by shielding effect of car top. Cannot be broken off or shorted out by snow, ice, or mud. Increases volume and distance. Works equally well on fabric top cars. Dealers, write for complete information and name of nearest jobber.

Sedan or Coach \$5.50 Coupe \$5.00

NORWEST RADIO LABORATORIES

3454 FULLERTON AVE. Dept. A-3, CHICAGO, ILL.

Western Division Shelby, Montana

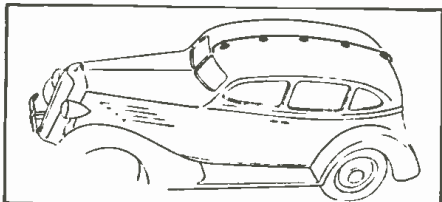

BUILD THIS BEAT OSCILLATOR FOR DX RECEPTION AND CODE

(Continued from page 410)

that, when placed alongside the control-grid lead of the last I.F. stage in the set, it will couple-in the local oscillation which it generates. The stronger the signal, the closer should be the coupling, but *vice versa* on weak signals; too much coupling will cause the A.V.C. to take hold and reduce receiver sensitivity. The unit is not furnished complete—being an experimenter's instrument—but parts may be obtained, with the grid coil tuned to 465 kc., so that it will beat against the standard I.F. signal; 300 to 500 cycles detuning will give a good note. Trimmer condenser C3 is adjusted with a screwdriver when necessary; the grid coil L2, tuned by condenser unit C2-C3, has a larger impedance—and higher D.C. resistance—than L1. (Since the instrument does not radiate it cannot cause outside interference.)

LIST OF PARTS

- One General Electric oscillator coil, No. RL-207, L1, L2;
- One General Electric carbon resistor, No. RR-187, 30,000 ohms, 1/2-W., R1;
- One General Electric carbon resistor, No. RR-050, 0.01-meg., 1/4-W., R2;
- One General Electric paper-dielectric condenser, No. RC-040, 0.01-mf., 400 V., C1;
- One General Electric padding condenser, No. RC-235, 100 mmf., C2;
- One General Electric trimmer condenser, No. RC-607, 35 mmf. max., C3;
- One General Electric mica dielectric condenser, No. RC-258, 250 mmf., C4;
- One General Electric mica-dielectric condenser, No. RC-202, 4 mmf., C5;
- One S.P.S.T. toggle switch, Sw.;
- One General Electric coil shield, No. RS-103;
- One General Electric wafer-type socket, No. RS-200;
- One RCA type 6C5 tube;
- *One adapter and cable assembly, No. 977MML.

*Names of manufacturers will be sent upon receipt of a stamped and self-addressed envelope.
This article has been prepared from data supplied by courtesy of General Electric Company.

The schematic circuit of the beat oscillator. This unit gets its power from the receiver to which it is connected.

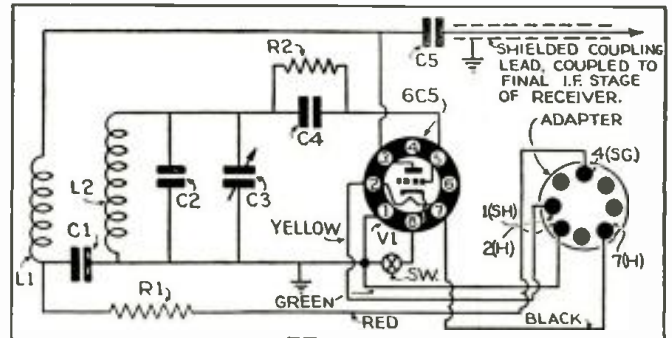

NEW "CURRENT-SAVER" CIRCUIT FOR 18-TUBE ALL-WAVE SET

(Continued from page 408)

A surprising by-product of this latter development is a total elimination of line voltage fluctuation effects. This former weakness of the oscillator was the reason why poor reception resulted when the line voltage dropped below normal.

The amplifier tubes decrease very little in efficiency with a 10 per cent decrease. Formerly, the oscillator would go down as much as 30 per cent in output on a 10 per cent decrease in line voltage. With the new oscillator circuit and slight changes in amplifier constants, it has been possible to so design a set that the output drops only about 2 per cent on a 10 per cent decrease in the line voltage.

Experimental work with this new set indicated that reception of the faintest short-wave signals was still possible at an applied line voltage of 56 V. However, in the final design, the voltage chosen for the "high-speed" tap was 70 V. in order to avoid critical operation and adjustment. An intermediate tap is provided, applying the equivalent of 90 V. to the primary.

ELECTRICAL TESTING LABS. REPORT

Reports on tests made by the Electrical Testing Laboratories of New York are astounding. Not only do they show a 50 per cent reduction of power consumption in "high gear," but also a comparison with 30 sets of other manufacture definitely proves the economy of operation. For example, the average power consumption for ten 6-tube sets was 76 W. The "modern" 18-tube set here illustrated, operating in high gear, consumes only 70 W.!

In these days of long-life components and low repairs, it is of prime importance to note that the voltages throughout the entire radio set are correspondingly lowered in such a way that less stress is thrown upon all condensers, windings and resistors. This will easily result in much longer life to all of these parts with a correspondingly lower repair bill.

This article has been prepared from data supplied by courtesy of Midwest Radio Corporation.

A NEW TRANSFORMER DEVELOPMENT

(Continued from page 412)

from which may be obtained current at voltages ranging from 400 to 560 V. By means of a primary tap these voltages can be varied approximately 12 per cent. This circuit is applicable to supply adequate power to 3 separate A.F. or R.F. units.

In applications where it is necessary to have separate low-voltage and high-voltage circuits, the circuit shown in Fig. 2 utilizing 2 type 866 tubes and a type 83 is not only economical but very practical for many uses in amateur stations and experimental circuits. The output current is approximately 140 per cent that for full-wave rating of single winding.

Figure 3 shows a similar application with the exception that the high-voltage arrangement is obtained from 3 low-cost 83-type tubes in a bridge arrangement. The same voltages are also obtainable by means of the connections shown in Fig. 4. In this circuit the center-tap of one of the high-voltage windings is connected to the filament of a type 83 tube, thereby forming a series or tandem connection that offers the utmost in simplicity and economy.

By far the most versatile hookup is shown in Fig. 5. A single 83 is used for low-voltage output; and two 866s connected for full-wave rectification supply the high-voltage output. Usually when this circuit is used in existing equipment 2 power transformers are required to accomplish what 1 will do with this new transformer.

Where higher voltages are desired the bridge circuit of Fig. 6 will supply a voltage as high as 1,620 V. D.C. The current output of "A" is 70 per cent of the rated full-wave value. In a circuit where such high voltages are used it is common practice to supply a lower power stage with a lower voltage. This is obtained from a separate winding using a type 83 tube in full-wave rectification.

For maximum voltage-per-dollar expended this circuit is ideal for those whose pocket book is limited. A glance at Fig. 7 shows 2 of the high-voltage windings connected in series. For rectification 2 type 83 tubes are connected in tandem. Low voltage is obtained from the other winding with another 83 tube.

When it is not desired to utilize a low voltage the 3 windings may be connected in series. When used as shown in Fig. 8, with 2 type 866 tubes, voltages ranging from 1,300 to 1,620 V. are procurable.

A more inexpensive method of obtaining the same voltages is shown in Fig. 9. Here the output circuits of 3 type 83 tubes are connected in series. In this circuit it is essential that the filament transformer supplying the 83 tubes be adequately insulated to withstand the high voltages.

Perhaps surpassing,

in flexibility, all circuits shown is the application in Fig. 10. In this circuit 21 different voltages are available. There is sufficient output available to supply transmitters ranging in power from 5 W. up to 500 W.

In addition to this a separate low-voltage supply may be taken from the secondary winding marked 4, 5 and 6, when the high-voltage requirements are not over 2,240 V.

The tabulated voltages and circuit connections obtainable from this circuit are as follows:

TABLE I

Primary Connection	Output Volts D.C.					
	X-12	X-11	X-9	X-8	X-7	X-5 X-4
O-1	450	900	1350	1750	1800	2250 2700
O-2	510	1020	1530	1990	2040	2550 3040
O-3	560	1120	1680	2180	2240	2800 3300

For circuits requiring exceptionally high current where the voltage requirement does not exceed 560 V. the circuit shown in Fig. 11 is admirably suited. By connecting two of the windings in parallel the current supply is doubled in the portion of the circuit marked "B." The usual low voltage is available from the third winding and will supply the full current ratings of the transformer.

While this cursory description only covers the more common types of rectification applications, the reader and especially the experimenter will no doubt find other interesting applications for this novel transformer. It should be noted in all applications where bridge rectification is used that the maximum output obtainable should never exceed 70 per cent of the rated output of the transformer.

The writer will be pleased to answer all inquiries relating to this article. Kindly enclose stamped, return-addressed envelope.

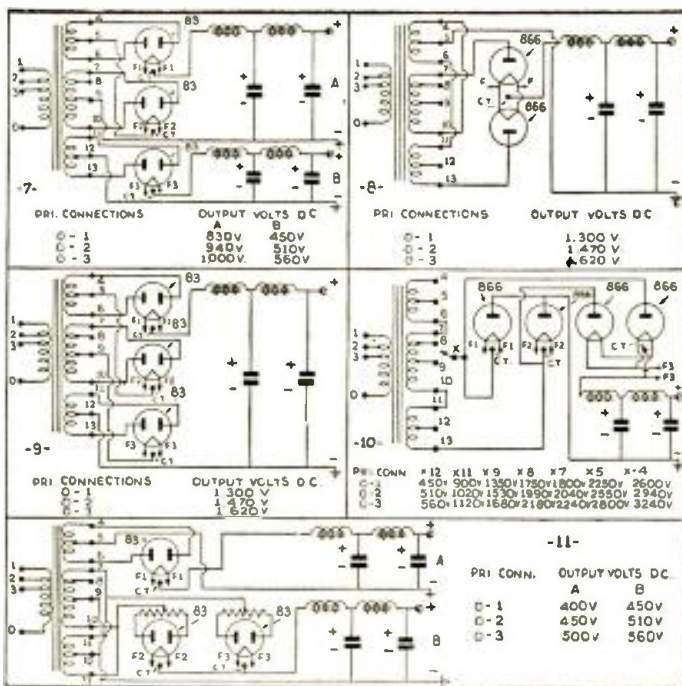

Figs. 7 to 11. Additional circuit arrangements.

USEFUL RADIO CIRCUITS

(Continued from page 411)

HONORABLE MENTION

USE YOUR HI-OHM VOLT-METER AS A TUNING METER. The high-resistance volt-meter, available to most experimenters, will serve nicely as a tuning meter if connected as shown in Fig. 7. No changes in wiring are needed. Simply remove an I.F. or R.F. tube, wrap the wire from the positive side of the meter around the cathode pin (or use a cathode contact wafer adapter) and replace the tube. The meter is now across the cathode resistance, and will record changes in cathode current.

O. T. PHELPS

HONORABLE MENTION

HOW TO ELECTRIFY BATTERY SETS. Battery-set owners who want to use 110 V. A.C. for their sets, without the cost of rewiring, will welcome the arrangement shown in Fig. 8. By using a type B-12 dry rectifier, as shown, with an "A" choke and filter, it is possible to get approximately 2 V. D.C. from a center-tap 6.3 V. secondary; and, for the plate supply, 175 V. can be obtained. A transformer of the type shown can be readily obtained.

EDWIN STELLHORN

Please Say That You Saw It in RADIO-CRAFT

Here's the "Key" to-
SUCCESSFUL SERVICING

-that opens the door to opportunity for **PROFESSIONAL SERVICE MEN**

STUDY AT HOME as low as \$5 MONTHLY



ADVANCED TRAINING IN RADIO SERVICE AND PUBLIC ADDRESS

The modern receiver is making many Servicemen "old fashioned"—men who have not kept pace with the new technical and complex developments by lack of technical training. Technical proficiency is essential if you desire to advance in the Service field.

TRAINED MEN WORTH MORE

Technical training is no longer a "luxury"—it is a NECESSITY! R.S.I. training was prepared, and is being constantly revised, by experienced men FOR experienced men. No waste material—but a complete home study course that starts paying for itself right from the first.

GOOD MEN HAVE GOOD JOBS

Look at the men about you. The men who have better jobs—have them because THEY are better qualified. You can't stand still in Radio—you either go ahead or go back. Be a success now—ability is always recognized. Start ANY time—take up to 3 years to complete. Get complete details today—the sooner the better.

RIGHT NOW—WRITE NOW!



• THIS BOOKLET IS YOURS

Free!

A request on a penny post card, will bring you your own copy of this interesting, illustrated booklet. Explains courses, school, faculty, terms and your future in the Service field.

RADIO SERVICE INSTITUTE

SUBSIDIARY OF CREI

Dept. RC-1, 3308 14th St., N. W., Wash., D. C.

• PORTABLE 19-WATT AMPLIFIER SYSTEM •

EMPLOYS TWO 12-INCH WRIGHT-DE COSTER "NOKOIL" DYNAMIC SPEAKERS
• WEATHERPROOF AND STURDILY CONSTRUCTED AEROPLANE CLOTH CASE •

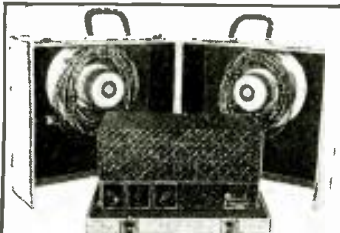

\$59.50

COMPLETE with R. C. A. TUBES MICROPHONE STAND

Your choice of a SURE crystal Mike or AMPERITE RAH velocity Mike. Floor or Desk stand.

Multiple Input Channels Crystal and Velocity mike input and phono pickup • Electronically Mixing Fading System • True High-Fidelity lifelike reproduction • Class "AB" amplification • 35 feet of rubber covered cable on each speaker with shielded plugs. • Polarized, Shielded and Armored Input and Output Receptacles • Unreserved Guarantee for Five Years.



Send for latest P.A. Catalog and Accessories

P. A. PROBLEMS
Consult our Engineering Staff and save money. Write us your requirements. With Full Details.

INDUSTRIAL
AMPLIFIER SYSTEMS COMPANY
16 RC HUDSON STREET NEW YORK, N. Y.

Tubes: 1-6J7, 1-6N7, 3-6P6, 2-5Z4 AS A SPECIAL OFFER!
When full remittance accompanies your order, you may deduct 5% . . . C.O.D. orders must be accompanied by a 20% deposit. (Code: Porcomp)

NOT A SHOT!!

After purchasing a number of articles, my friend and I stood waiting for a bus. Just before it arrived I turned to my companion and asked that he give me the "forty-five," warning him not to drop it as it would explode. With that, an officer standing behind us took hold of my arm and asked gruffly if I had a permit to carry a gun. Laughing at his question, I held out the "forty-five"—a recently purchased radio tube!—G. Baunhauber (from the New York News, New York.)

Now—a high-powered—



Radio Engineering Library

—especially selected by radio specialists of McGraw-Hill publications

—to give most complete, dependable coverage of facts needed by all whose fields are grounded on radio fundamentals

—available at a special price and terms.

These books cover circuit phenomena, tube theory, network, measurements, and other subjects—give specialized treatment of all fields of practical design and application. They are books of recognized position in the literature—books you will refer to and be referred to often. If you are practical designer, researcher or engineer in any field based on radio, you want these books for the help they give in hundreds of problems throughout the whole field of radio engineering.

New

The Library now comprises a revised selection of books culled from latest McGraw-Hill publications in the radio field.

5 volumes, 3064 pages, 2000 illustrations

1. Glasgow's PRINCIPLES OF RADIO ENGINEERING
2. Hund's PHENOMENA IN HIGH-FREQUENCY SYSTEMS
3. Chaffee's THEORY OF THERMIONIC VACUUM TUBES
4. Terman's MEASUREMENTS IN RADIO ENGINEERING
5. Henney's RADIO ENGINEERING HANDBOOK

10 day examination. Special price. Monthly payments. \$25.00 worth of books cost you only \$23.50 under this offer. Add these standard works to your library now; pay small monthly installments, while you use the books.

SEND THIS ON-APPROVAL COUPON

McGraw-Hill Book Co., Inc.
330 W. 42nd St., New York, N. Y.

Send me Radio Engineering Library, 5 vols., for 10 days' examination on approval. In 10 days I will send \$2.50, plus few cents postage, and \$3.00 monthly (1st \$23.50 is paid, or return books postpaid. We pay postage on orders accompanied by remittance of first installment.)

Name

Address

City and State

Position

Company

RC-1-37



UNIVERSAL
Velocity and Carbon Microphones

Universal's latest achievement—Ideal for stage use—Not affected by temperature or humidity—Flat frequency response curve from 40 to 10,000 c.p.s.; Output-63 D.B.; Low impedance or direct to grid types. Compact, 2 1/2 x 4 1/2 in. by 1 1/2 in. thick—Weight, less than 18 oz.—Headwires to any desired angle—Beautifully finished in black enamel and artistic chrome plate—ask for new catalog sheet describing models RL, RP, RH and CR—List \$22.50—Latest model music type optional stand for above microphones—List \$10.00.

UNIVERSAL MICROPHONE CO., Ltd.
424 Warren Lane Inglewood, Calif., U. S. A.

WPA POLICE-RADIO "NOISE DETECTIVES"

(Continued from page 402)

of disturbances, and the other 5 will determine the cause for the disturbance.

EQUIPMENT AND PROCEDURE OF THE "QRM AND QRN DETECTIVES"

The "radio noise (or 'QRM' and 'QRN') detectives" utilize an ordinary receiving set tuned to the wavelength of the police transmitter. The set is portable, equipped with earphones and a directional loop antenna, increasing the selectivity and sensitivity of the set. In addition, the volume control is connected with a meter, which will register the amount of volume or power necessary to bring in signals clearly.

The men will make a complete tour of the County, tracking down interference in the following manner: A "detective," walks down "D" Street, earphone on his head, listening to the police announcer. Reception is distinct and clear. As he continues down the street, however, a faint click-click is heard in the phones. The noise becomes louder with each step. The "detective" walks on. The click-click starts to fade. He turns and goes back. He repeats the process until the static or interference has reached its peak in loudness.

He notes his location. He is standing in front of 417 "D" Street, let us say. He looks up and sees an electric flash sign over his head. It is probably the cause of the interference which has drowned out the police station.

On his map showing "D" Street, he checks 417 as an interference spot. By a wavy line along a horizontal scale he also shows the increase and decrease of the reception clarity at different locations along the length of the street, as well as the amount of volume necessary to bring in the police transmission clearly.

The checkers, with permission of the property owners, investigate the flash sign the next day. The entire electrical system connected with the suspected sign is examined. The wiring and apparatus is searched for leaks, short circuits, and improper installation. In the flash sign they find the wiring had been improperly grounded, and that a light type of cable was used where a heavier one was necessary.

Representatives of the City's electrical division will be sent to the address and request cooperation in the elimination of the disturbance. Samuel B. Finklestein, administrative clerk, explains. If the procedure does not bring results, legal steps can be taken under a City ordinance compelling approval of commercial electrical apparatus.

The Federal Communications Commission is working on a method of control for apparatus not covered by present laws, such as X-ray and diathermy machines. Necessity for rigorous methods of enforcement, however, is not anticipated.

- ### SOURCES OF INTERFERENCE
- The disturbances encountered fall under the following 5 general classifications:
- (1) Street railway interference.
 - (2) Interference from industrial equipment.
 - (3) Interference from domestic appliances.
 - (4) Power line interference.

(5) Interference from electro-medical apparatus.

To the uninitiated, interference caused by these disturbances is similar to static heard on the home radio set. Actually, every type of interference has its own individual sound which can be detected by the trained ear.

The interference caused by the flash sign sounds like the click-click-click of a typewriter. Trolley cars cause an increasing and diminishing hum in the earphones. Poor insulation in a transformer between the house service line and equipment, results in interference sounding like a series of heavy crackles.

Every spot in the County that produces disturbances will be investigated and the cause checked.

The radio-interference detectives will start first on known disturbance centers, where police cars have reported inability or difficulty in receiving headquarters signals.

In cases where faulty equipment or installation is found, the procedure mentioned above will be followed. Where equipment is found to be satisfactory but a disturbance still exists, recommendation will be made that an interference filter be installed between the incoming electrical line and the equipment. The filter, consisting of condensers and choke coils in various combinations, absorbs and chokes the electrical sparks that cause interference.

When the crews have completed their check on the streets in the County, approximately 14,000 miles of highways will have been covered, and all disturbances recorded on the street charts. Each chart will represent not more than 2 blocks, and will show volume needed for reception.

Next, 11 maps—one for each 2 of Essex County's 21 municipalities and 1 for the City of Newark—will be made from the field charts, showing volume levels of audibility.

They will be ordinary maps of the district, covered by colored curved lines to indicate the intensity of reception. A section through which a red line runs, for example, may indicate strong reception. From these maps the strength of the transmitter necessary to reach all points can be determined.

WHY THIS "NOISE SURVEY?"

Elimination of disturbances will mean, first of all, that lower-powered transmitters can be used, thereby saving the expense of more powerful equipment.

The decrease in interference will promote police radio efficiency as well as that of private short-wave, all-wave, and broadcast radio receivers.

This is the first comprehensive survey specifically for short-wave ever to be made, according to Lieutenant Leo J. Donohue, project planner of the Professional and Service project in Essex County.

Headquarters for the project will be the upper-floor of the repair department building of the Newark Department of Public Safety at Lafayette and Congress Streets.

Finklestein, administrative clerk under Public Safety Director Michael P. Duffy, will have general supervision of the project. He is in

Please Say That You Saw It in RADIO-CRAFT

**Learn SOUND RECORDING
TALKING PICTURE PROJECTION
TELEVISION-RADIO**

Master training courses qualify you for good jobs. Practical, easy to learn. Newest equipment. 30,000 graduates. Earn room and board while learning. Coach R. R. fare allowed to L.A. Write for FREE BOOK. Address Dept. R-10, 4000 S. Figueroa St.

NATIONAL SCHOOLS - Los Angeles

4 BAND SUPER TUNING UNIT

RANGE 12 to 550 METERS **\$9.95**
COMPLETE WITH 6" DIAL
STAGE OF R.F. ON ALL 4 BANDS

Write for New 20-Page Flyer

ARROW SALES CORPORATION

631 WASHINGTON BLVD. CHICAGO, ILL.



**6L6 Transformer Kit
30 Watts**

Power Trans. 800 VT CT-250 mfd 5 V.-2 Amp. 0.3 Volts at 6 Amp. Net \$3.50. Input Trans. High Fidelity type \$3.00 net. Output 500 ohm and tapped voice coil \$3.00 net. Diagram of 6L6 30 Watt Amplifier with all latest circuit improvements and full parts list 25c. Special for above kit, \$8.00 net.

AALLOY TRANSFORMER CO., Inc., 135R Liberty St., N.Y. City

**OXFORD
NEW SPEAKERS**

... with "Changeable Fields" and Universal Transformer, bring you new convenience, performance and economy in Speaker Replacements. Ask your Jobber or Write today for Bulletin 361C.

OXFORD-TARTAK RADIO CORP.
915 W. VAN BUREN ST. CHICAGO, U.S.A.

NEW GUIDE NOW READY!

Most complete volume control facts ever assembled in one book. Free with top (showing spec. number) of one Electrad volume control carton.

Write Dept. RC-1
175 Varick St., New York, N.Y.

ELECTRAD

**PHILCO SERVICEMAN and
CATALOG of PHILCO PARTS
and TUBES... Sent Free on Request**

WILLIAMS PHILCO, Inc.
800 S. Adams St. Peoria, Ill.

New Lynch **GAIN CONTROL**
"NAME-TAGS"

Silver letters on black background. An economical method of dressing up your equipment. Requires no drilling to mar your panels. Thirty names from which to choose. **5c**

Write for Complete List Today!
LYNCH MANUFACTURING COMPANY, INC.
CRANFORD NEW JERSEY

RADIO ENGINEERING

RCA Institutes offer an intensive course of high standard embracing all phases of Radio. Practical training with modern equipment at New York and Chicago schools. Also specialized courses and Home Study courses under "No obligation" plan. Catalog Dept. RT-37.

RCA INSTITUTES, Inc.
75 Varick St., New York 1154 Merchandise Mart, Chicago
Recognized Standard in Radio Instruction Since 1909.

**A New Line of...
DRY ELECTROLYTIC CONDENSERS**

SMALL, COMPACT - REASONABLY PRICED
Dealers, Distributors, Jobbers and Service Men
Write for Information and Price Sheets
Unconditionally Guaranteed

ILLINOIS CONDENSER COMPANY
3252 W. NORTH AVE., CHICAGO, ILL.

charge of the police radio maintenance shop, has a radio operator's license and was admitted to the bar in 1916. He is a member of the American Radio Relay League, and has his own transmitter. In discussing the project, Henry Epsel, chief operator of the Newark police station, W2XEM, pointed out that radio disturbances appear in quite unexpected places.

(Note—Radio-Craft readers will recall Mr. Gernsback's editorial, "Man-Made Static," which appeared in the October, 1936, issue, pg. 197. As there suggested local interference problems—relating not only to police-signal reception but also to all-wave reception of regular broadcast programs—in many instances may receive the attention of trained "static hounds" if the interference conditions are brought to the attention of the National Committee for the Prevention of Radio Interference, 21 Rhame Ave., East Rockaway, L. I., N. Y.

It is interesting to note further, in passing, that surveys conducted, along lines here outlined by Mr. von Struve, in other counties and states throughout the United States will be welcomed as a boon to tens of thousands of technicians and non-technicians, alike.—Editor)

ORSMA MEMBERS' FORUM

(Continued from page 408)

curacy could be attained if all readings were to be taken at the half-scale reading of the meter.

The meter may be constructed for any range desired. I will describe the construction of a "10-ohm maximum" meter.

For this range the meter used must have a resistance (Rm) of 10 ohms. This is achieved by use of a suitable shunt. The meter I use has a resistance of 30 ohms, and a range of 1 ma. A 15-ohm shunt reduces the Rm of the meter to 10 ohms, and increases the current to 3 ma.

Using 22.5 V. of battery, with Rx open and Sw.1 closed, the total circuit resistance including the resistance of the meter will be 7,500 ohms, and the current for full-scale deflection will be 3 ma. Under these conditions a 10,000-ohm wire-wound resistor R1 will be adequate. If your meter has a resistance of 50 ohms, then reducing it to 10 ohms will increase the current to 5 ma., and a 5,000-ohm rheostat will serve as R1.

Resistor R3 is a high-grade rheostat of large size, and consisting of many turns of low-resistance wire, and with a range of 0-10 ohms. This is the most important piece of apparatus used, and must be capable of fine adjustment.

Unit R2 is a fixed resistor of 5 ohms. In use the battery is connected, R1 is set first to maximum resistance, and Sw.1 closed. Resistor R1 is now adjusted for full-scale reading of the meter. The resistor to be measured is plugged into the tip jacks, Rx, Sw.1 opened, and resistor R3 adjusted until the meter reads half-scale. The pointer of R3 will read directly the value of Rx in ohms, but must first be calibrated to do this.

With the shorting shunt, short terminals Rx, and adjust R3 until the meter reads half-scale. This will indicate R3 as having a resistance of 10 ohms, the same as the meter, and will indicate zero position of R3. Remove the shorting shunt, connect an accurate resistor of 10 ohms across Rx and again adjust for half-scale. This will indicate the maximum position of the pointer on R3. It will be realized that heavy bus wire must be used for all connections, so that with R3 at maximum position there is no appreciable resistance in the shunt circuit. To fill in the graduations, either a decade resistance box, a number of accurate resistors of small value, or a calibrated rheostat for R3 may be used.

NORMAN S. DAVY,
Birch River,
Manitoba, Canada.

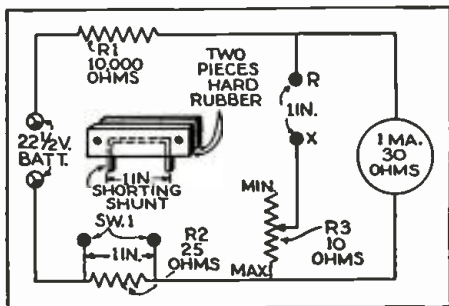

The circuit of the short ohmmeter.

Please Say That You Saw It in RADIO-CRAFT

**GREATER PERFORMANCE
AT LOWER PRICE**

**DEPENDABLE
TUBE TESTER**

MODEL 305 ONLY

\$21.95



Tests every type of receiving tube made today and provides for future use... Tests shorts and leakages... individual tests of Diode, Triode, Pentode, etc. sections of the combination type tubes... Ohmmeter, Continuity and Condenser Tester included... Many other attractive features.

**DEPENDABLE
MASTER
MULTITESTER**

for only

\$31.50



41 Meters in One

A portable testing instrument superior in range, accuracy and convenience. Costs much less and does much more than any other similar testing instrument in this field.

Measures resistance from 1/2 ohm to 40 million ohms in 6 ranges. Capacity from .0001 to 300 mfd. in 5 ranges. AC & DC milliamperes from 10 microamperes to 2 1/2 amperes in 6 ranges. AC & DC voltages from 1/10 volt to 1000 volts in 5 ranges. Inductance in 5 ranges and decibels in 4 ranges. Employs a new and highly improved method of making AC measurements. A splendid meter for output measurements.

**DEPENDABLE
MULTITESTER**

MODEL 403A ONLY

\$13.95

2000 ohms per volt



Sensational value in a low price instrument. Meter accuracy within 2%. Measures volts to 1/10 to 750 1/4 ohms to 2,000,000 10 microamperes to 50 milliamperes.

Complete with batteries

For detailed information about these and many other DEPENDABLE instruments write for attractive free catalogue to Dept. C

See your jobber or write direct to the factory

RADIO CITY PRODUCTS CO.

88 PARK PLACE NEW YORK CITY "DEPEND ON DEPENDABLE"

SERVICE MAN'S REPLACEMENT PARTS KIT

Here is the ideal selection of essential parts that will enable you to service any type of radio receiver or amplifier. All parts are brand new and the products of famous nationally known manufacturers.—This kit consists of:

- 25 by-pass condensers; 4 Wet Electrolytic condensers; 1 Low voltage, 50 volt cathode by-pass condensers; 100 Resistors, ranging in 1/3, 1/2 and 1 watt; 6 Dry Electrolytic Filter condensers; 200-600 Volts; 8 Assorted volume controls, with and without switches; 2 Boxes Pilot Lights 2.5 and 6.3 volts (10 in a box); 6-110V. Pilot lights for A.C. Midset Sets; 3 lbs. radio hardware, consisting of nuts, bolts, and washers; 1 Roll tape; Washers; Service Man's Spaghetti and wire assortment; 3 A.C. resistance line cords; 1 2 1/2 volt power transformer; 1 Lb. roll of Rosin Core Solder; 1-6 Volt power transformer.

Regular Trade Discount Value **\$29.00**
Your special price, Shipping Weight—15 lbs. **\$13.95**
AD-7000 Professional Service Man's Kit ...

**ATTENTION: SERVICE MEN
AND RADIO EXPERIMENTERS**

Send for our latest, RED HOT BARGAIN BULLETIN.

UNITED RADIO COMPANY
58 MARKET ST. DEPT. M NEWARK, N. J.

Be an INTERFERENCE expert!

Christmas tree flashers, electric razors, toys, flatirons, toasters, heater pads, and many other electric devices interfere with the holiday radio programs.

Practically all interference from electrical devices, both in your own home and from your neighbors' homes, may be eliminated with CONTINENTAL Carbon Filternoys Suppressors, F01DH, F505DH, or F1005DH.

For radio servicemen, Filternoys units constitute a profitable extra sale on every service call.

Order at dealer prices, C.O.D., your sample kit of the three best selling Filternoys suppressors. List price, \$10.00. Money back guarantee!

SEND THIS COUPON!

CONTINENTAL CARBON INC.
13914 Lorain Ave., Cleveland, O.

- () Send bulletins on noise elimination.
- () Send, C.O.D., kit of three Filternoys Suppressors. List price, \$10.00.

Name

Address

Jobber's Name

Dealer's prices granted only if your radio jobber's name is listed.

.00001 Ohm to 11 Megohms SHALLCROSS Hi-Lo Resistance Bridge

A direct reading instrument for the measurement of low resistances encountered in relay contacts, coil and armature windings, as well as other resistance of any character within the range of the bridge.



Combines in one instrument a standard Kelvin Bridge and a standard Wheatstone Bridge for measuring resistances from .00001 ohm to 11 megohms.

Send for Bulletin 637-P.

SHALLCROSS MFG. COMPANY
Electrical Measuring Instruments and Accurate Resistors
700 MAC DARE BOULEVARD
COLLINGDALE, PA.

THE LATEST RADIO EQUIPMENT

(Continued from page 415)

to minimize undesirable external coupling. Top and bottom terminal boards prevent stray-field pick-up; close fit to metal cases gives maximum shielding.

DECORATIVE COMPACT SET (1240)

THREE plastics, in different colors, form the modernistic case of this "Kadette" 6-tube super., tuning down to 1,725 kc.; the grille is of *tenite*, the top is of *plaskon*, and the body is of *bakelite*. A ballast tube eliminates hot power cord; 2nd-detector functions as A.V.C. Impregnated coils, like cabinet, are tropical-weather-proof. Large airplane dial, right-hand tuning, dynamic speaker, attached aerial.

AUTOMATIC TAPE TRANSMITTER (1241)

BUILT to meet amateur demand, this equipment perforates a paper tape with uniformly-spaced dots and dashes, by means of the cutting lever at the side. This is then run by a tiny A.C. motor between roller-type contacts, as an endless belt, it will repeat a call or message over and over. Cast aluminum case is 5" square.

SOUND ON FILM PROJECTOR (1242)

DEFINITELY in the low-cost field, this equipment has many high class features. The prefocused 500 W. lamp is cooled by a powerful blower. The motor is adjustable as to speed and has an electrical governor. Motor rewind is possible without changing reels or belts. The A.C.-D.C. amplifier has an output of 8 W. and uses 7 tubes. A socket is provided for microphone or phonograph. Speaker is mounted in a separate

case and has 50 ft. cable. Tone and volume controls are provided.

CRYSTAL OSCILLOSCOPE (1243)

SEVERAL types of this instrument are made, the difference being in the range of frequency response. That shown is made for a range up to *1,000 cycles. Others cover up to **5,000 and ***10,000 cycles. (Coupling capacities—*0.005-mf.; **0.001-mf.; ***500 mmf.) The cases are of brass, oil-filled to protect the crystal units. The lowest impedance in the frequency range is about 30,000 ohms, so that an ordinary triode may be used as a driver. The maximum safe applied voltage is 100; at a 10-in. radius, a 2 in. band is then covered by the light spot. The actuating element is a tiny bimorph (composite) crystal, one end of which is fastened in bakelite, and the other having a 1/4-in. square mirror fastened to it. (An adjustable stand may be had for laboratory use.)

WIRE STRIPPER (1244)

OPERATED by a foot pedal, this stripper assures clean and rapid results. It can be adjusted to accommodate wire from No. 8 down to the finest sizes. The feed is from the side; all parts are in sight. May be used for stripping single or duplex wire and for center or end stripping.

NON-EXACT REPLACEMENT TRANSFORMER (1245)

THOROUGH impregnation against all moisture and atmospheric conditions assure trouble-free operation of these units. They are designed to be used in those receivers for which there are

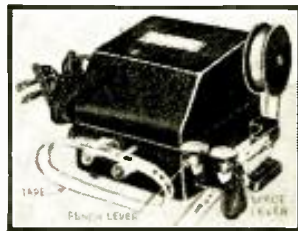

Tape transmitter. (1241)



Wire stripper. (1244)

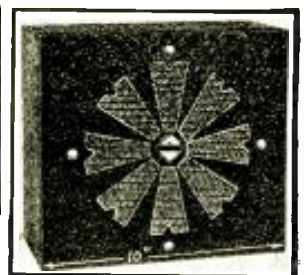

Separate speaker in metal cabinet. (1248)

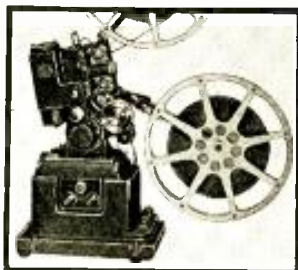

Film projector. (1242)

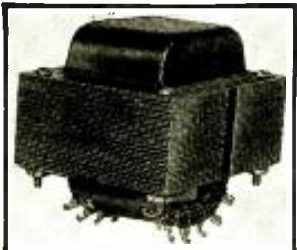

Replacement transformers. (1245)

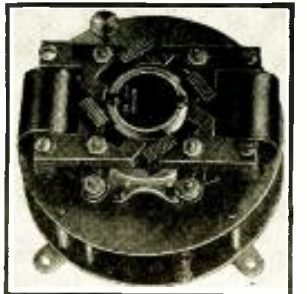

Self-starting synchronous clock motor. (1249)

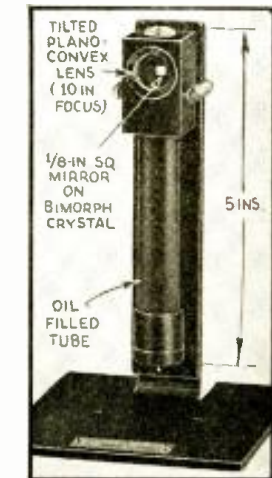

Crystal oscilloscope. (1243)

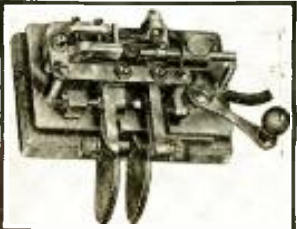

Bug telegraph key. (1246)

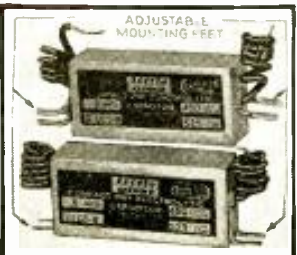

Filter condensers. (1247)

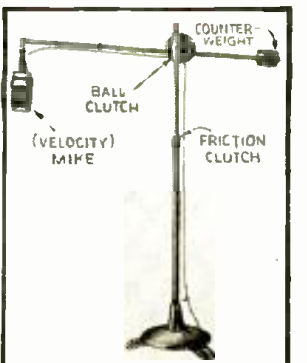

Silent boom stand for mikes. (1250)

Please Say That You Saw It in RADIO-CRAFT

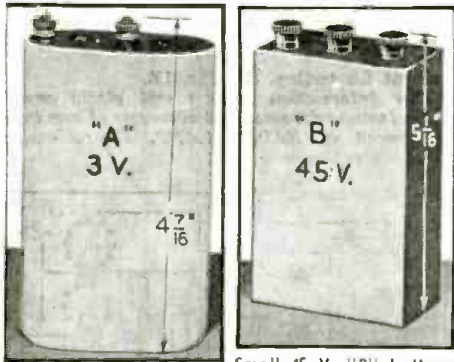

Tiny "A" battery, (1251) for portable use. (1251)
Small 45 V. "B" battery

no exact duplicates, and are made in sizes from 4 to 12 tubes. The core laminations are so mounted as to remove all possibility of mechanical hum production.

"BUG" TELEGRAPH KEY (1246)

THE side-swiping, semi-automatic key is intended for high-speed operation, in either radio or land-line telegraphy. It is used, in radio transmission, with a relay. The key is tuned, so that its vibrating reed sends dots and dashes rapidly as its paddles are manipulated. With the cover (removed for photo) it is $3\frac{1}{4} \times 2\frac{5}{16} \times 2\frac{1}{4}$ ins. high. Large tungsten contacts work against silver, to give long life. An expert's instrument.

FLEXIBLE CONDENSER MOUNTING (1247)

(Solar Mfg. Co.)

MIDGET dry electrolytic condensers, with high rating and large capacity in small cases, are provided with flexible tabs, rotating so that they can be used to mount these components either flat or on edge, with more substantial hold than the lead wires afford. They can thus be secured in otherwise difficult corners, etc.

METAL CABINET AND SPEAKER (1248)

(Wright-De Coster, Inc.)

FOR amateurs, experimenters and engineers requiring a high-quality separate speaker, that illustrated has been brought out with all-metal cabinet in black crystalline finish and black and grey grille cloth. Supplied with either permanent-magnet dynamic of 5-watt capacity, or balanced-armature magnetic type. The former has universal transformer, to match output tubes; the latter 7- and 10-thousand ohm impedances. Size of cabinet 10 x 9 high x 5 ins. deep.

CONTINUOUS CLOCK MOTOR (1249)

ABILITY to continue running for about an hour after the current has been shut off is a feature of this electric clock movement that will appeal to experimenters. The electric portion is self-starting and all moving parts run in a constant sealed bath of oil. The movement is noiseless and vibrationless and maximum speed of 1,800 R.P.M. is reached almost instantaneously.

SILENT "BOOM" STAND FOR MIKE (1250)

(Amperite Corporation)

IN the movies, all know, a boom is used to bring the mike into position to catch the hero's confidences to the heroine. A similar type of mike support, useful in many studio pick-ups, is available, as shown. It is silent in its adjustment, controlled by clutches which hold it as set at any desired height or angle. Obtainable in chrome and gunmetal finishes.

COMPACT BATTERIES (1251)

DESIGNED especially for ultra-high-frequency and other portable use, these units afford the maximum possible life. The 3 V. battery at A measures $4\frac{7}{16} \times 2\frac{1}{2} \times 1\frac{11}{32}$ ins. deep, while the 45 V. unit at B is $5\frac{1}{16} \times 2\frac{13}{16} \times 1\frac{1}{4}$ ins. deep.

(Continued on page 438)

The Complete Service Laboratory By CLOUGH-BRENGLE

Down payment \$12.00 (and up)

Let the prestige building ability of these massive complete laboratories build profits for you.

Cabinets are C-B green with silvered Lumaline floodlight and black front panels. Every dial, name plate, and control stands out to intrigue the customer's eye and build confidence in your work.

With the new C-B Easy Payment Plan you can bring this modern complete equipment into your shop for less money than you are accustomed to paying for a

small portable instrument. Ask your jobber for full details or write today for the new descriptive bulletin.

Write for Descriptive Bulletin

The C-B Laboratory Cabinet holds any standard 19" panel in which form all present and future C-B instruments are optionally offered. Buy the cabinet and one instrument. When more equipment is desired, the blank filler panels may be quickly removed.

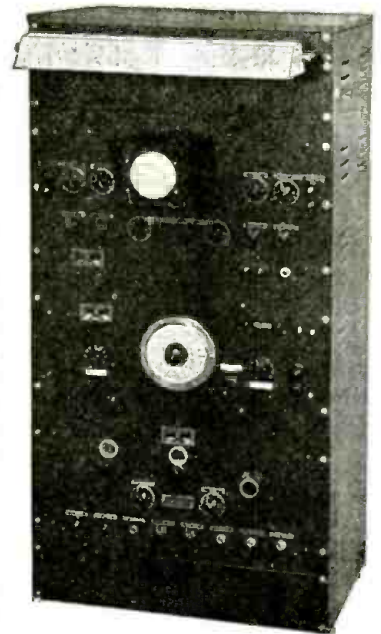

The CLOUGH-BRENGLE CO.

2809 W. 19th St.

Chicago, U. S. A.

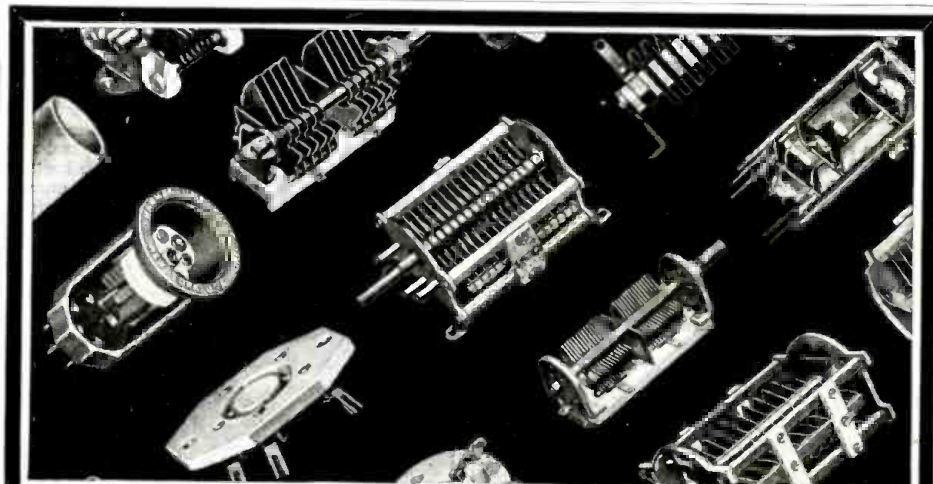

SPECIFIED AGAIN!

TWENTY-FIVE years ago, the first Hammarlund precision products made their appearance, to the applause of the radio engineering world. Their dominant superiority became a by-word in laboratories, industrial plants, schools, and homes the

world over. Today, specialists, continue to show their approval of these distinctive Hammarlund units by specifying their use in every conceivable type of radio instrument. Shown are a few Hammarlund parts used in the "1937 Television Receiver."

Write Dept. RC-1 today, for new "37" catalog with complete description of all Hammarlund products!

THE HAMMARLUND MANUFACTURING COMPANY, INC.
424-438 WEST 33RD STREET, NEW YORK CITY

HAMMARLUND'S 25th YEAR

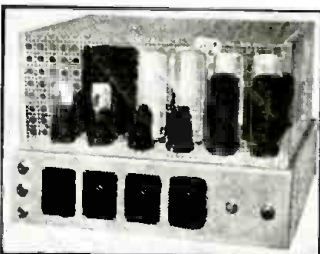

REALISM IN SOUND by AMPLITONE

All AMPLITONE amplifiers are capable of realistic reproduction, and are engineered to give a maximum of service at optimum efficiency. A full line of P.A. systems and accessories for every purpose or application!

DE-LUXE BEAM POWER AMPLIFIER—This unit, shown in adjacent photo, is intended for quality installations. It has a conservative power output rating of 60 watts, peak power of 80 watts. It is a hi-fidelity amplifier, incorporating beam suppression, 2-channel inputs, beam-power tubes, etc. Full details mailed upon request. **\$49.50 NET PRICE, less tubes**

MULTI-PURPOSE, 6V D.C.—110V. A.C. AMPLIFIER—This unit is very popular with P.A. men, since it is adaptable to both sound track and indoor P.A. work. Rated *output* at 20 watts, peak power of 35 watts. Dual channel inputs,—overall gain 115 DB which permits use of velocity microphones without further pre-amplification. Descriptive circular mailed on request. **\$33.50 SPECIALLY PRICED, less tubes**

FREE!—DESCRIPTIVE CATALOGUE AND ADVICE ON P.A. PROBLEMS
AMPLITONE PRODUCTS COMPANY • 135 Liberty Street, New York City

Please Say That You Saw It in RADIO-CRAFT

SAVE MONEY

Make the "Old" Tester "New" Again

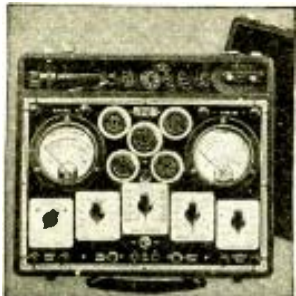

(Modernized Set Analyzer)

MODERNIZE YOUR OBSOLETE TUBE CHECKER OR SET ANALYZER WITH "PRECISION"

This modernization service is available for most of the popular TUBE CHECKER and SET ANALYZER models. Instruments are brought "up-to-the-minute" with all the advanced and tested engineering refinements that go into the construction of a "new job." "Precision" modernizations incorporate accuracy... flexibility... ease of control... true professional appearance. When writing for details please mention make and model number of your old instrument.

WRITE FOR OUR PLAN Modernization Division Department "C"

PRECISION APPARATUS CORPORATION
821 East New York Avenue, Brooklyn, N. Y.

Learn RADIO from REAL RADIO ENGINEERS!



- Kenneth Clough, Chief Engineer, Clough-Brangle Co.
- E. E. Gramer, Chief Engineer, Standard Transfer Co.
- Karl E. Hessel, Chief Engineer, Zenith Radio Corp.
- F. H. Schnell, Radio Engineer, Grunow Radio
- Dr. C. M. Blackburn, Production Dept., P. R. Mallory & Co.

Many R-T-I Trained Men Earn up to \$75 a Week and More

These industry appointed engineers, who work for large radio manufacturers, will supervise your training at home, and get you ready for Good-pay jobs in Radio Broadcasting, Installation, Servicing, Public Address System and Phon Electric Cell work. Also for coming activity in Television. Opportunities for properly trained men better than ever before. Earn while you learn. Some make \$5 and \$10 a week extra in spare time one to two weeks after starting. Many earn up to \$75 a week in full time, job or their own business, some even more. No other training like mine. Get the facts if you want a better job. Write now for my free book.

RAY D. SMITH, President.

RADIO AND TELEVISION INSTITUTE
Dept. 221, 2150 Lawrence Avenue, Chicago, Ill.

RADIOS

ALL NEW 1937 MODELS



A penny post card brings you our new, full-color 16-page BARGAIN CATALOG free. Many models to choose from. 4 to 10 tubes; AC DC. All-Wave and new Four sets that operate like city radios. Send post card or coupon below for full details of 30-day no-risk trial and Agent-Care proposition. Write now!

30-DAY NO-RISK TRIAL

MAIL COUPON *Free Catalog*

Enjoy it a month, then decide. Write!
GOLDENTONE RADIO CO., Dept. B, DEARBORN, MICH. Without obligation, send me new 1937 Catalog and 30-day trial plan.
Name: _____
Address: _____

NEWEST CAR-RADIO SERVICING PANEL

(Continued from page 418)

The speaker can be matched to single or double output stages. (The non-reflecting etched panels, indirect lighting and large scales make all reading easy.) See Fig. 1. The power supply is built-in, a vibrator supplying the 6 V. direct

current for testing. See Fig. 1E.

Our Information Bureau will gladly supply manufacturers' names and addresses of any items mentioned in RADIO-CRAFT. Please enclose stamped return envelope.

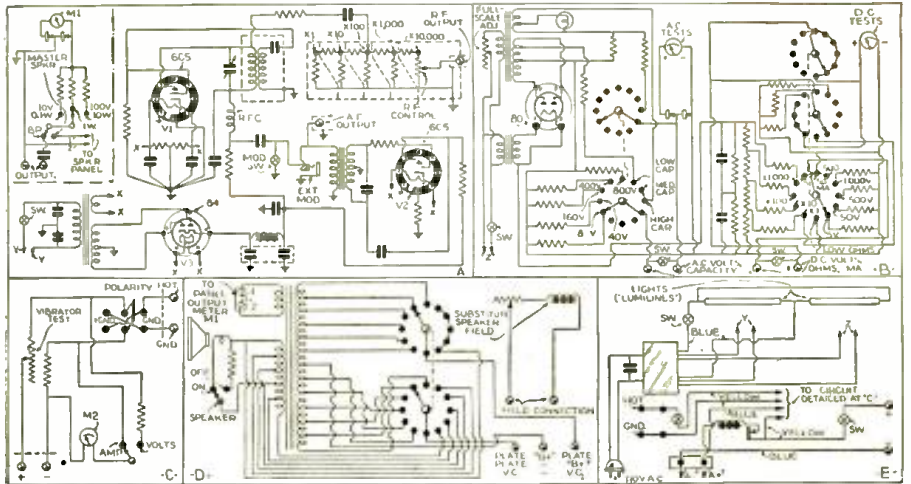

The circuit of the complete car-radio servicing panel described. Unit E connects the other panels.

THE LATEST RADIO EQUIPMENT

(Continued from page 437)

GAS-TYPE FIRE EXTINGUISHER (1252)

DRY carbon dioxide jets, recognized as superior to combat electrical, as well as gasoline fires, are provided on the *Queen Mary* to control any outbreak in her big power plant. A little brother is illustrated which is the size for shop, garage or car use. It weighs only 10 1/2 lbs.; does not deteriorate with keeping; and is easily recharged with carbon dioxide after use.

SOUND SYSTEM SECTIONS (1253) (The Webster Company)

FOR extension on the unit plan, a new program and speech distributing equipment has been brought out. Radio, microphone and phonograph are provided; each distributing unit will take care of ten rooms.



Dry carbon-dioxide gas fire extinguisher. Especially useful for "electrical" fires which makes it particularly suited for radio service shops. (1252)

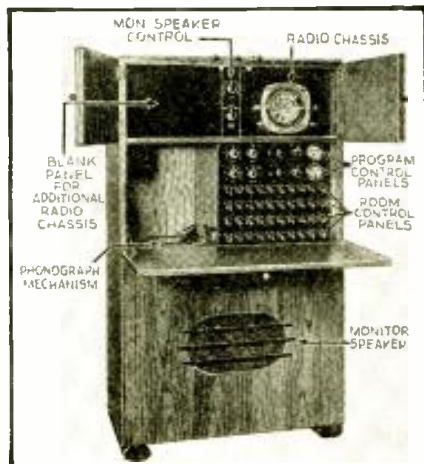

A sectional type program distributing unit. (1253)
Please Say That You Saw It in RADIO-CRAFT

ORPHANS? NO!

They bear the RCA Trademark!

10,000 replacement parts, available at all times, prevent RCA Radios from becoming orphans—regardless of the set's age!



PASSING years and worn parts make no difference if the radio bears the RCA trademark. For no matter how old the set... no matter what part of its chassis needs replacement—the part is available.

There are 10,000 RCA replacement parts ready to serve owners of RCA Radios. All are of the same fine quality that was originally built into the set and sell at low prices. If your local dealer or distributor does not have the part you require on hand, he can obtain it for you quickly and easily.

RCA PARTS FOR PROFIT
RCA Manufacturing Co., Inc., Camden, N. J.
A service of the Radio Corporation of America

POWERTONE

Model 801—Pocket Volt-Ohmmeter



A sensitive, compact and accurate volt-ohmmeter that will be the finest instrument in your "lab." or out on jobs. 150 volt-ohm readings, 0-50, 500 and 1000. Resistance readings from 1/2 to 500 and 500 to 500,000 ohms. Will read from 0 to 1 Mh. Low resistance range direct reading. Meter has 1000 ohm per volt sensitivity. Battery is self contained. Panel is clearly lettered. Compensation provided for zero adjustment. Complete with test leads. Measures only 2 3/4" x 2 1/2". Your price complete with battery.

\$5.75

Send for complete literature on a variety of test instruments

JOBBER'S WRITE IN FOR PROPOSITION

POWERTONE ELECTRIC CORP.

179 Greenwich Street New York City
 Distributor
TRY-MO RADIO CO., Inc.
 85 Cortlandt St. New York City

SHORT WAVE CONVERTERS FOR CAR RADIOS



Can be attached to any car radio. Has on and off switch and does not affect the reception on the standard broadcast band.

Model 300 covers the 15 to 49 meter bands. Designed for the foreign trade. With this unit one may receive London, Berlin, South America, etc. List Price 19.95

Model 100 Police converter with fixed condenser covers 1500 to 2600 Kilocycles. List Price 9.95

Model 200 Police converter with variable condenser and illuminated dial. Covers 1500 to 5500 kilocycles. List Price 17.95

Model 400 Police converter with fixed condenser. Covers the ultra short wave bands from 5 to 10 meters. List Price 13.95

Jobbers and dealers wanted

ABC RADIO LABORATORIES 3334 N. New Jersey St., Indianapolis, Indiana, U.S.A.

To Readers of RADIO-CRAFT

FREE POSTCARDS MAY BE HAD UPON WRITING TO THE PUBLISHERS

These postcards make it easy to answer advertisements which appear in RADIO-CRAFT, without cutting valuable data which you may wish to save.

Many times manufacturers request you to "clip the coupon" when answering their ads. Often this means destroying part of an article on the reverse page you may need later for reference. Save your RADIO-CRAFT issues complete. If you should ever want to sell bound volumes, or certain copies of RADIO-CRAFT, the resale value of uncut issues is very much higher than that of mutilated ones. So send for a supply of these free post cards and use them in answering all RADIO-CRAFT advertisers.

BUILD IT YOURSELF

You can build this Trailer with ordinary tools easily from our step-by-step constructional sheets and large sized blueprints.

Finest designed Trailer in existence, sleeps 4. Toilet. Shower. Electric Light, etc.

Save 75% of the cost by building it yourself. Send 25c for plans sheet, illustrations and details.

THE PLAN SHOP, 910 Palmolive Bldg. Chicago, Ill.



RADIO REPAIR CEMENT

"THE ORIGINAL SPEAKER CEMENT"

Used for replacing speaker cones, mending old, rattling, or torn cones, galling adjustments, cementing loose tube bases, grid caps, coils, leads etc. Dries fast. Vibration proof, waterproof. Invaluable aid to Service Men. See your jobber, if he cannot supply you, write us.

List price 50c for large bottle. Send for FREE circular of complete line.

GENERAL CEMENT MFG. CO.
 (Radio Div. Rockford, Illinois)

RADIO COURSES

RADIO OPERATING: Prepare for Gov't License Exam. ● RADIO SERVICING: Including Short Wave ● AMATEUR CODE ● ELECTRONICS ● TELEVISION ●

Day and Evening Classes—Booklet Upon Request

New York YMCA Schools
 4 W. 64th Street, New York City

SUN-SPOTS AND SHORT-WAVE RADIO FADE-OUTS

(Continued from page 402)

outs might be produced by the sudden and spectacular eruptions of gaseous material from sun-spots that are suspected of causing magnetic storms and the aurora. Consequently he urged astronomers to make special observations of the sun, and radio operators to be alert for unusual disturbances, whenever a fade-out is expected.

SHORT-WAVE OBSERVATIONS AT MOUNT WILSON OBSERVATORY

At the Mount Wilson Observatory of the Carnegie Institution of Washington, located at Pasadena, California, an attempt has been made to photograph the sun continuously on the days when a fade-out was supposed to occur. Five of these 54-day periods have now passed, and on all except one either a major fade-out or unusual transmission difficulties were reported!

Solar observations could not always be made because of clouds, but on the dates of 4 of these fade-outs brilliant sun-spot eruptions were seen either in England or at Mount Wilson. 3 of which were apparently connected with radio anomalies. In addition, an examination has also been made of photographs of the sun taken in the past at Mount Wilson. By a fortunate coincidence, plates had been taken while the fade-outs were actually in progress on 3 of the 5 dates first reported to Dr. Dellinger, and all 3 showed sun-spots to be in eruption at the time. But perhaps the most striking case of all occurred on April 8, 1936 when a sun-spot eruption big enough to engulf the entire earth and a widespread fade-out were observed to occur within a minute of each other. It is here that the short-wave listener-in can be of help by noting the exact time of the fade-outs, so that we can determine whether the eruptions and fade-outs are actually coincident or not.

Future fade-outs may be predicted for 1937 on January 3, and March 26, but it must be emphasized that these dates may easily be in error by as much as 10 days. Anyone really interested in following-up this effect should make a note of anything unusual in short-wave reception, regardless of whether or not it occurs near these dates. It is hoped that a careful and systematic comparison of radio and solar phenomena over a period of several years may result in a better understanding of conditions that influence short-wave radio transmission.

(The author, Mr. R. S. Richardson, is associated with the Mount Wilson Observatory and Carnegie Institute of Washington—the work of this observatory in recording radio fade-outs and their relation to astronomical phenomena has been reported in the pages of *Radio-Craft* in recent issues. Incidentally, television investigators are awakening to the importance of research such as here reported by Mr. Richardson.—Editor)

OPERATING NOTES

(Continued from page 418)

condenser, a 5-mf. electrolytic unit. A highly microphonic condition will also result when this condenser breaks down, as well as a motorboating hum that is heard as soon as the manual noise-suppressor control is turned even slightly counter clockwise.

The complaint of reception cutting off sharply, and the presence of circuit oscillation and motorboating throughout the entire tuning range have been frequently traced to an open-circuited screen-grid bypass condenser, a 0.5-mf. tubular unit.

Lyric SA-133, 1300. When these receivers are serviced for a loud hum which develops as the tubes reach their normal operating temperature, and the grids of the 2A5 tubes glow red, check for a grounded R.F. choke in the high-voltage secondary circuit.

A loud, disturbing arcing that is heard at high volume levels is caused by the voice coils arcing over to the field-magnet pole pieces. If cleaning and re-centering the voice coils do not overcome this difficulty, try connecting a 50-ohm resistor from the ungrounded side of the output transformer secondary to ground. Should this cut volume down too much or the arcing-over is still present, decrease or increase the value of this resistor, as the case may be.

BERTRAM M. FREED.

SAVE Time! Money! Shoe Leather!

"SHOP WHOLESALE!"

EVERYTHING YOU NEED IN RADIO

IT'S SMART TO BE THRIFTY

Get the habit... Shop in your Slippers... it's EASIER—it's ECONOMICAL. Use the BIG FREE 1937 Radio Catalog to save Time, Money, Shoe Leather, for this book contains the most comprehensive collection of radio values ever assembled in 156 pages of a catalog. Whatever your radio requirements, you'll find them here—remember—Wholesale offers COMPLETE stocks of FRESH, STANDARD merchandise and twenty-four hour shipments.

XMAS ELECTRICAL SPECIALS

Our Special Xmas Electrical Catalog points the way to easy and economical buying of electrical gifts this Xmas. A swell collection of electrical toys, household equipment, etc. Send for it TODAY... it's FREE!

Free SEND FOR OUR CATALOGS...

WHOLESALE RADIO SERVICE CO., INC.
 100 Sixth Ave., New York, N. Y.

Check ()

Rush Free Radio Catalog 65A3 ()

Rush Free Xmas Electrical Catalog 67A3 ()

Name

Street

City State.....



BIG VALUES in Small Bulk

Maximum capacity or capacities... adequate working voltage... compact cardboard case... economical service life... and very lowest cost. That's the story of AEROVOX PBS series electrolytics.

Unit shown is dual 4-4 mfd. 450 V. Note size comparison. Separate leads for sections. Color-coded for polarity indication.

Single, dual and triple section units. 200 and 450 V. working. Popular capacities. Handy mounting lugs. Extreme compactness at no sacrifice of performance.

Ideal general-purpose units for condenser repairs in absence of AEROVOX exact duplicate replacement condensers.

New CATALOG: More pages. More items. More choice. Lower prices. Write us or ask your local AEROVOX jobber for copy.

AEROVOX CORPORATION

70 Washington St. : : Brooklyn, N. Y.

Please Say That You Saw It in RADIO-CRAFT

FREE

The World's Most Comprehensive Catalog of **AMPLIFIERS** and **P.A. Sound Systems**



Write for Catalog No. 3709 which lists more than 87 ultra-modern amplifiers together with complete details of the latest anti-howl, automatic audio volume control, volume expander, and floating audio beam power amplifiers. No P.A. Technician can afford to be without it. **SEND YOUR P.A. PROBLEM TO A. C. SHANEY, FOR FREE CONSULTATION.**

Dealers, Jobbers and Distributors write for attractive proposition.

Public Address Division
AMPLIFIER CO. OF AMERICA
37 West 20th Street New York, N. Y.

Sensational RADIO VALUES

4-Tube AC-DC Set
Buy at factory prices—Save money! Lowest priced good radio on the market. Uses 4 latest type tubes, sensitive magnetic speaker, aeroplane dial, built-in antenna and attractive cabinet with beveled corners. Astonishing volume and tone quality. Works 1-6CB, 1-6DB, 1-43 and a 25Z5. Works anywhere—on any 110-volt circuit. Covers the standard broadcast band. A real portable personal set. Can be carried anywhere.

\$6.45

5-Tube A.C.-D.C. Dynamic Speaker
Short-Waves—Aeroplane Dial

\$8.95

5 latest tubes, 6" dynamic speaker, illuminated aeroplane watch dial, built-in antenna, beautiful two-tone cabinet. Two models, viz: Broadcast Model (\$8.95) and Short-Wave and Broadcast Model (\$9c extra). Works on any 110-volt line—AC or DC. Order directly from this "Ad." Send certified check or money order. 20% deposit required for C.O.D. orders. **WRITE TODAY FOR FREE ILLUSTRATED CIRCULAR—large selection of latest sets at money-saving prices.**

PARAMOUNT TRADING CO.,
80 EIGHTH AVE. NEW YORK CITY.

MILLION TUBE TESTER

FEATURES

1. Emission
2. Metal Tubes
3. Shorts HOT
4. Leakage H01
5. Resistance
6. Electrolytics
7. By-Pass Condensers
8. Neon Alignment

MODEL CN
\$9.95 NET

Here's what the Service Men say about the New Million Tube Tester: "Most valuable purchase of test equipment we made during the last year." "It shows up weak tubes better than my expensive tester."
If your jobber cannot supply you—order direct—20% deposit required on C. O. D. orders. Tear out this ad and send it to us NOW for information on complete line.

MILLION RADIO AND TELEVISION LABORATORIES
361 W. SUPERIOR ST., CHICAGO, ILL.

HOW TO GET "LONG DISTANCE" ON YOUR ALL-WAVE SET

(Continued from page 403)

alent to 11,750 kc. The frequency is a large number. Therefore, it has become the practice when dealing with short-wave stations to give their frequency in *megacycles* instead of kilocycles. *Mega* means million, while *kilo* means a thousand. Therefore, a kilocycle is really a thousand cycles and a megacycle is a million cycles. Consequently 1 megacycle (mc., for short) equals 1,000 kilocycles or kc. Thus the station whose frequency is 11,750 kc. can be identified as operating on 11.75 mc. Note that the last figure of the frequency in kilocycles is generally dropped when using kilocycles. Megacycles are not used with regular broadcast-band stations because there the kilocycle method is satisfactory since the figures involved are small. Station WLW on 700 kc. could be written as 0.7-mc. if desired. For aid in remembering the difference between these three, a list giving the meters, kc. and mc. of a number of reference points is given, as follows: 50 meters equals 6,000 kc. or 6 mc.; 30 meters equals 10,000 kc. or 10 mc.; 24 meters equals 12,000 kc. or 12 mc.; 15 meters equals 20,000 kc. or 20 mc. (Also, see Fig. 1.)

SHORT-WAVE TUNING

Looking for short-wave stations is an entirely different procedure than tuning-in stations on the regular broadcast band. On the latter range most persons can be certain of hearing their favorite stations at approximately the same loudness and clarity whenever they listen for them.

Short-wave reception is not at all like this, however. Certain wavelength or frequency bands are suitable for long-distance reception from a given point only at certain times of the day. In addition, the season of the year plays an important part in determining what wavelengths will be most suitable for transmission to certain areas at any given time.

GENERAL RULES FOR BEST S.-W.

Do not expect to be able to turn on your radio set and tune-in a certain short-wave station at any time of the day. This is impossible. First of all the factors mentioned is the effect of the time of day on reception. (See Fig. 2.)

Reception Conditions During Daylight. During broad daylight the shorter waves or higher frequencies are the only ones capable of providing long-distance reception. Thus the waves from 10 to 20 meters (15-30 mcs.) give best results when there is daylight either at the station; at the receiver; or, at both places. The shorter the wave, the better it is for daylight communication.

The stations operating near 20 meters (15 mc.) are heard best in the Fall and Winter when there is daylight over most of the distance between the station and the listener. The stations below 15 meters or above 20 mc. are heard best during these seasons when there is daylight over the whole path. Practically, this means that European stations operating near 15 mcs. are heard best in the U.S.A. at this period from 4 to 7 a.m. and 11 a.m. to 4 p.m. The stations above 20 mcs. are heard best from 7 to 11 a.m. Asiatic and Australian stations in these bands are heard best from 9 a.m. to 7 p.m.

Reception Conditions at Night. The stations operating between 25 and 35 meters (12 and 8.5 mcs.) are heard best when there is darkness over most of the path between the listener and the broadcast station. Thus the Europeans in this band are heard best from 4 p.m. to 5 a.m. Asiatic and Australian stations are heard best from midnight until 9 a.m. Wavelengths from 35 to 60 meters (8.5 to 4 mcs.) give best long-distance reception when the whole area is in darkness. Europeans are heard in this band from 6 p.m. to 2 a.m. At present this band does not give very good reception of European stations at any time; the higher frequencies are superior for this purpose. However, many South American stations can be heard from 5 p.m. until 6 a.m. in this band and especially near 6 mcs. The waves above 60 meters (below 4 mcs.) are not suitable for long-distance reception (over 2,000 miles), at present.

The listener should remember that on the short-wave bands the higher frequencies are best for long-distance daylight reception and the lower frequencies for night-time reception. Also, the season of the year determines which frequencies are the best.



Learn More About RADIO and A B C of AIR CONDITIONING

THE RADIO-CRAFT LIBRARY SERIES—a most complete and authentic set of volumes—treats individually, important divisions of radio. Each book has been designed to give you the opportunity to learn one or more branches of radio. The authors of the books are well-known to everyone. Each is an expert radio man; an authority on the subject—each is thoroughly familiar with the field which he represents.

All Books Uniform

The volumes in the RADIO-CRAFT LIBRARY SERIES are all uniform, 6 x 9 inches. Each book contains on an average of 50 to 120 illustrations. The books are printed on an excellent grade of paper which makes the type easy reading.

- No. 1
RADIO SET ANALYZERS
By L. VAN DER MEL
- No. 2
MODERN VACUUM TUBES
By ROBERT HERTZBERG
- No. 3
THE SUPERHETERODYNE BOOK
C. J. FITCH
- No. 4
MODERN RADIO HOOK-UPS
By R. D. WASHBURNE
- No. 5
HOW TO BECOME A RADIO SERVICE MAN
By LOUIS MARTIN
- No. 6
BRINGING ELECTRIC SETS UP TO DATE
By CLIFFORD E. DENTON
- No. 7
RADIO KINKS AND WRINKLES
By C. W. PALMER
- No. 8
RADIO QUESTIONS AND ANSWERS
By R. D. WASHBURNE
- No. 9
AUTOMOBILE RADIO AND SERVICING
By LOUIS MARTIN
- No. 10
HOME RECORDING AND ALL ABOUT IT
By GEORGE J. SALIBA
- No. 11
POINT-TO-POINT RESISTANCE MEASUREMENTS
By CLIFFORD E. DENTON
- No. 12
PUBLIC ADDRESS INSTALLATION AND SERVICE
By J. T. BERNSELY
- No. 13
A B C OF AIR CONDITIONING
By PAUL D. HARRIGAN
- No. 14
POCKET RADIO GUIDE
By NAT LESSEM

BIG DISCOUNT OFFERED
When Five (5) Books or More Are Ordered, Deduct 20%

RADCRAFT PUBLICATIONS, INC.
99 Hudson Street, New York, N. Y.

RADCRAFT PUBLICATIONS, INC. RC-137
99 Hudson Street, New York, N. Y.

I have circled below the numbers of books in the RADIO-CRAFT LIBRARY SERIES which you are to send me, and have deducted 20% for ordering five (5) books or more. I have included my remittance in full, at the price of 50c each, when less than five books are ordered.

The amount of my remittance is..... (stamp checks or money orders accepted). Circle numbers wanted:

1 2 3 4 5 6 7 8 9 10 11 12 13 14

Name

Address

City State

All books are sent postage prepaid

Please Say That You Saw It in RADIO-CRAFT

FACTORY TO YOU

LATEST MODEL REMINGTON TYPEWRITERS



10¢ A DAY

BRAND NEW, latest model Remington Portable for only 10¢ a day! Amazingly low price direct from the factory. Every essential feature of large office typewriters—standard 4-row keyboard, standard width carriage, margin release, back space, automatic ribbon reverse. Act now, while this special opportunity holds good.

You don't RISK a Penny

We send you this genuine Model 5 for 10 days' free trial. If not satisfied, send it back. We pay all shipping charges.

FREE Typing Course and Carrying Case

You will receive FREE a complete simplified home course in Touch Typing. Also FREE, a handsome, sturdy carrying case. No obligation. Mail coupon for full details—NOW.

Remington Rand Inc.: Dept. 189-1
315 Fourth Ave., New York, N. Y.

Tell me, without obligation, how I can get a New Remington Portable, plus Free Typing Course and Carrying Case, for 10¢ a day. Send Catalogue.

Name.....
Address.....
City.....State.....

JOBS & CAREERS

The Only Magazine of Its Kind

TELLS HOW:

- To Look for a Job
- To Better Your Present Position
- To Plan Your Career
- To Choose an Occupation
- To Earn Money in Spare-Time
- Inside Stories of Successful Men, Etc., Etc.

On all newsstands 25¢.
If your dealer cannot supply you, send a quarter and we will forward a copy at once

JOBS & CAREERS
520 N. Michigan Ave., RC-137, Chicago, Ill.

CLASSIFIED ADVERTISEMENTS

Advertisements in this section are inserted at the cost of twelve cents per word for each insertion—name, initials and address each count as one word. Cash should accompany all classified advertisement, unless placed by a recognized advertising agency. No less than ten words are accepted. Advertising for the February, 1937, issue should be received not later than December 7th, 1936.

A.C. AUTO GENERATORS

TURN SCRAP INTO MONEY. AUTOPOWER SHOWS you how easily and economically auto generators can be converted into A. C. or D. C. generators and D. C. motors, 2 to 1000 volts; for sound, radio, power, light, or welding. No previous experience necessary—complete information all in new book, with simple instructions and illustrations. Endorsed by thousands. Only \$1.00 postpaid. Autopower, Inc., 108-X S. Hoyle Ave., Chicago.

INSTRUCTION

WORK FOR "UNCLE SAM." \$105-\$175 MONTH. Men-women. Try next held examinations. List jobs and full particulars free. Write today. Franklin Institute, Dept. T-3, Rochester, New York.

RADIO

RADIO ENGINEERING, BROADCASTING, AVIATION and police radio, servicing, Marine and Morse Telegraph taught thoroughly. All expenses low. Catalog free. Dodge's Institute, Pine Street, Valparaiso, Indiana.

In Summer the higher frequencies give better results, even at night, while in Winter the lower frequencies are the most effective and provide the clearest signals. The various short-wave stations realize this and generally broadcast on 2 or more frequencies, *simultaneously*, using a high and a low frequency. These stations also change the operating frequencies several times during a day shifting to lower frequencies as darkness approaches. They also make seasonal changes in frequencies used to insure good reception at all times. A great many newspapers carry daily schedules of the best-heard short-wave foreign stations; these station lists give last-minute details as to the exact frequencies being used at any time. There are also a number of magazines which publish the operating schedules (frequency, and time on the air) of all stations.

WHERE THE STATIONS APPEAR ON THE DIAL

Most of the short-wave broadcast stations are heard within the following regions on the dial of a receiver: 5.8 to 6.3 mcs.; 9.45 to 9.7 mcs.; 11.7 to 11.9 mcs.; 15.1 to 15.35 mcs.; 17.75 to 17.8 mcs. and 21.45 to 21.55 mcs. (See Fig. 2.)

Stations are heard outside of these bands but the great majority of stations are heard within them so the new listener would do well to confine his attention to these areas, at first.

Another point to remember is that most stations are not on the air all day as are the regular local broadcast stations. If a certain station is not heard when tuned-for, it is possible that it is not broadcasting at the moment. If the suggestions given here are followed the short waves should yield a great deal of entertainment and many thrills.

AN EASILY-BUILT CONDENSER ANALYZER FOR THE SERVICING BEGINNER

(Continued from page 413)

once and go out; a shorted condenser gives a steady glow; a leaky condenser makes the bulb flash intermittently.

For checking leakage of electrolytic condensers, the milliammeter used has a scale of 5 or 10 ma. and has shunts for multiplying the range by 10 and 100. Be sure the rotary switch Sw.3 is the type that shorts between contacts. Note that the "OFF" position shorts out the milliammeter to provide for the initial surge of current when an electrolytic is connected to the tip-jacks marked Common and Mils. After the condenser charges, the switch may be thrown to the other positions for reading leakage current. Electrolytic condensers which show a leakage of more than about 1 ma. per mf. are defective.

LIST OF PARTS

- One Weston Model 476 A.C. voltmeter, 0-150 scale;
- One Weston D.C. milliammeter, 0-5 ma. scale; and multiplier shunts for 50 and 500 ma.;
- One Blan the Radio Man neon lamp, 1 or 2 W.;
- One Blan the Radio Man rotary switch, 4-point, for 500 V., Sw.3;
- Two Blan the Radio Man snap switches, for 110-V. line;
- Three Insuline tip-jacks;
- Two Insuline test prods and leads;
- Six binding posts;
- One Blan the Radio Man light plug and cable, wire, etc.;
- One cabinet or baseboard for mounting.

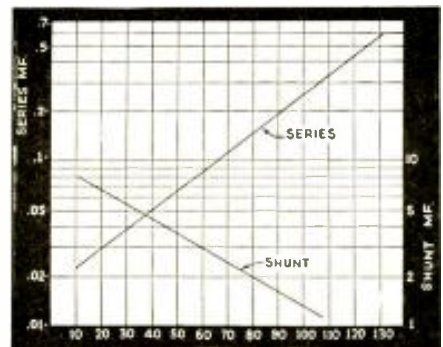

Sample series and parallel curves.

Please Say That You Saw It in RADIO-CRAFT

A Complete Line of Complete P. A. Systems

U.S.E.'s Systems are built around rugged high fidelity Amplifiers, featuring latest developments and design. Everything from 10 watts to 240 watts output. Reasonably priced.

Write for No. 106 catalog. Get the U.S.E. proposition for handling this line in your territory.



USE 60 WATTS NET AUDIO OUTPUT **\$76.26**

UNITED SOUND ENGINEERING CO.
2239 University Ave., St. Paul, Minn.

Strictly REPLACEMENT

FOR those Servicers who prefer a paper dielectric bypass or filter condenser, Cornell-Dubilier have perfected the Type PE condensers. These high quality paper dielectric condensers simulate electrolytics in appearance, though actual capacity is 1/3 to 1/2 that of electrolytics they are to replace.

Check these outstanding features found only in the PE SERIES

- No Polarity To Observe.
- No Leakage.
- Negligible Power Factor Characteristics.
- Conservatively Rated.

FOR AN ECONOMICAL AND GOOD SERVICE JOB USE PE PAPER CONDENSERS.

THE WORLD'S LARGEST EXCLUSIVE CONDENSER MANUFACTURERS

PAPER MICA
DYKANOL WET & DRY
ELECTROLYTICS

CORNELL-DUBILIER CORP.
1014 Hamilton Blvd.,
So. Plainfield, N. J.

CORNELL DUBILIER

RADIO

holds great rewards for trained men



The big opportunities in Radio will be enjoyed by trained men. The International Correspondence Schools Radio Course, prepared by leading authorities and constantly revised, will help make you a trained man! A fascinating book - FREE.

AVIATION ENGINEERS are leaders in modern progress



Aviation depends upon engines, and knowledge of aviation engines is a long step toward success in this rapidly growing industry. Many leading aviation engineers today took their first step by mailing a coupon to the I. C. S. at Scranton. Why don't you follow their example?

INTERNATIONAL CORRESPONDENCE SCHOOLS

Box 6677-C, Scranton, Penna.

Explain fully about your course in the subject marked X:

- | | |
|---|---|
| <input type="checkbox"/> RADIO | <input type="checkbox"/> AVIATION |
| <input type="checkbox"/> Chemistry | <input type="checkbox"/> Accountancy |
| <input type="checkbox"/> Invention | <input type="checkbox"/> Advertising |
| <input type="checkbox"/> Refrigeration | <input type="checkbox"/> Electrical Engineering |
| <input type="checkbox"/> Air Conditioning | <input type="checkbox"/> Drafting |
| <input type="checkbox"/> Architecture | <input type="checkbox"/> Show Card Lettering |
| <input type="checkbox"/> Good English | |

Name.....Age.....

Address.....

BARGAIN BULLETIN
SAVE MONEY ON EVERYTHING YOU BUY!

SPORTING GOODS
WATCHES-CLOCKS
TYPEWRITERS
OPTICAL GOODS
CAMERAS-NOVELTIES

RADIO SETS AND REPLACEMENT PARTS

New 100-Page Catalog Just Out!
SEND FOR YOUR FREE COPY TODAY!

Buy efficiently, economically, safely! Hundreds of high quality items—leading lines and standard brands—at prices amazingly low! Real bargains! Square dealing! Write today for your big, free copy of this new catalog hot off the press.

RADIO CIRCULAR CO., INC.
915 BROADWAY Dept. RC NEW YORK, N. Y.

NEW FIELD FOR RADIO MEN

Sell our complete line of 16 MM and 35 MM motion picture equipment for theatres, institutions, clubs and home use. We have everything. Tremendous field; liberal profits. Write TODAY.
S.O.S. CORP. 1680-RA B'DW'Y, N.Y.C. CABLE-SOSOUND, N.Y.

"HAM" SPECIAL Standard Teleplex
A highly efficient code teacher using heavy specially prepared waxed paper tape, having two rows of perforations. Write for Free folder A1. We are the originators of this type instrument
TELEPLEX CO.
Instrument with tapes prepared by expert and complete course. All for \$22.95. Without Oscillator. 72-76 Cortland St., N. Y. C.

EXPERIMENTS WITH A HI-FI AMPLIFIER

(Continued from page 409)

volume control, and a dummy impedance of the same value as the impedance of the speaker (to provide suitable balance for the entire line when any one or more speakers are taken out of service). The simple single-pole double-throw switch, indicated in the diagram connects the loudspeaker into circuit when the switch is thrown in one direction and throws the reproducer out of circuit, replacing it with the fixed impedance, when the switch is thrown in the opposite direction.

In a circuit of this nature the best results will be obtained if the volume control is made up of the T- or H-type, connected across the speaker. The T-type provides semi-constant impedance while the H-type is known as a constant-impedance volume control. (A comprehensive booklet on this subject has been prepared by the engineering department of a well-known manufacturer*, and is available for the asking.)

The matter of providing a suitable panel mounting for the control of each speaker will suggest itself to the experimenter who is in the habit of making and operating devices of this nature, but we suggest the following. A regular electrical outlet box having a face plate with 2 holes such as is used in connection with the ordinary push-type electric switch as shown in Fig. 2H. The balancing impedance is placed inside the box and one hole is used to mount the volume control while the other is used to mount the single-pole double-throw switch. This latter may be of the regular electrical toggle variety or it may be one of the typical radio switches. The impedance-matching unit, which is thrown into circuit when the reproducer is thrown out of circuit, is simple to procure; it may be a 500-ohm resistor of the 10-W., wire-wound variety.

Various types of loudspeaker arrangements may be employed and there is no limit to the experimentation that may be conducted by the owner of an amplifier of this nature. If 2 speakers are employed in the same room they should be so arranged as to prevent the sound waves from one, striking the front surface of the cone of the other. One system that has worked out very satisfactorily for us has been to use a triangular type of baffle, mounted in the corner which is made up by the ceiling and 2 side walls. The second speaker has been similarly mounted in a corner at the opposite side of the room. The angles at which the speakers are faced are arranged so that the sound waves reflected by the bare floor, when the room is used for dancing, will not strike the front surface of either speaker. In most instances it will be found that this difficulty will be automatically obviated by the absorption which is produced by the clothing of the dancers.

It should be remembered that high fidelity is only possible where the high-frequency notes of a musical selection appear in their normal percentages. When the ordinary type of high-frequency reproducer is employed, the sound which it emits proceeds in a comparatively straight and rather narrow line from the orifice of the speaker. Unless the speaker is mounted at a high position in the room, as suggested above, much of the brilliance of tone, which is provided by the higher audio frequencies, never reaches the ear of the listener. To a large extent this difficulty is obviated by the arrangement we have suggested.

Placing a loudspeaker in the center of a large wall using that wall for a baffle is all right as far as the reproduction of the low frequencies is concerned but this procedure suffers in the same way as the ordinary type of reproduction in that the high frequencies are sent out from the speaker in a straight line. If the reproducer is at level of the ears of the auditors the high frequencies appear to be accentuated when they are directly in front of the loudspeaker and they seem to be completely lacking when they move a slight distance to one side or the other.

The subject of the correct placement of loudspeakers for securing the most satisfactory results is a study in acoustics which offers a very wide field of experiment, concerning which very little practical knowledge is as yet available.

*The name and address of the manufacturer will be supplied upon receipt of a stamped and self-addressed envelope.

G. E. PHONOGRAPH MOTOR

\$4.95



VARIABLE speed induction type self-starting, 110 volt, 25 to 60 cycle, AC, with speed control. Plug and cord. Speed range from 5 to 200 RPM. Can be installed in place of old-fashioned, hand-winding speed motor. Also ideal for display turn table, and a hundred other uses. These G.E. Electric Motors are brand new, in original factory cartons. Same motor that formerly sold \$15.00. Only \$4.95

Shipping weight—12 lbs.

ONLY \$4.96 U. S. NAVY AIRPLANE-TYPE Microphone and Receiver

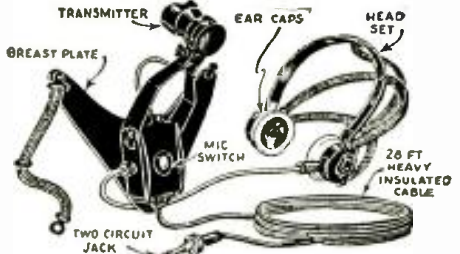

THIS Microphone and telephone headset outfit was built especially for the U.S. Navy Aviation Corps for Plane-to-Plane and Plane-to-Ground communication.

The Holtzer-Cabot Electric Company constructed the outfit to Government specifications and under rigid Navy Department supervision.

The outfit consists of a low-impedance carbon microphone (transmitter), securely fastened to a metal breast-plate, and a set of heavy-duty, low-impedance earphones. A specially constructed switch on the back of the breast-plate controls the microphone circuit. The earphones are U.S.N. Utah type, attached to adjustable headband. Twenty-eight feet of very heavy weather and waterproof conductor cable, terminating in a special brass plug, is furnished with this complete outfit. Current of not more than 10 volts should be used. A storage battery is the most satisfactory current supply. Talk in a natural tone of voice, when using the outfit, with the lips close to the mouth-piece. Shouting and loud talking should be avoided.

We understand that the U.S. Government paid more than \$40.00 for each of these outfits. We have bought the whole lot at a low price and are offering them, as long as the supply lasts, at \$4.96 each, complete as shown in illustration. The shipping weight is 9 lbs.

All merchandise in original packages—never used. Money-back guarantee.

All Shipments will be forwarded by Express Collect if not sufficient postage included.

WELLWORTH TRADING CO.
560 W. Washington Blvd., Dept. RC-137, Chicago, Ill.

Please Say That You Saw It in RADIO-CRAFT

BASIC OSCILLATOR CIRCUITS YOU SHOULD KNOW

(Continued from page 410)

OSCILLATOR IS A "JUNIOR" BROADCAST STATION

The oscillator is, in short, a broadcast transmitter, of very great tuning range, although intended for reception only in one room. Its design, construction and functioning, therefore, follow transmitting technique, so far as wave (signal) generation is concerned.

The 3-Circuit Regenerator. The old-fashioned regenerative broadcast receiver, with which broadcast listening started (or, at least, passed beyond the crystal stage) was a transmitter when the grid was "tickled" too much; as the neighbors oftentimes found to their sorrow. In those days, sets interfered with each other often more than other man-made static! The reason is that the regenerative set (Fig. 1A) feeds back R.F. energy from its plate into its control-grid circuit; and this grid circuit in turn feeds it back into the antenna. Such a set is, in fact, an oscillator and, if properly calibrated, could be used as a "service oscillator" or so-called "signal generator." In fact, some ingenious early radio experimenters did this very thing, if crudely; and we still find circuits of this type in use.

In a receiver, nowadays, oscillation is permitted only in special tubes; but in the old regenerative detector it was used to obtain sensitivity—usually at the expense of quality. For one thing, it was hardly ever possible to tune the regenerative detector to the exact frequency of the received

signal, and this changed the audio quality of the reproduction. But here we are not bothering with a received signal; though it is desirable to have our oscillator frequency as correct as possible, when working with sets calibrated, and I.F. transformers, etc., peaked to a certain figure.

Reversed-Feedback Oscillator. The circuit just shown is the tuned-grid tickler-feedback or "3-circuit" type, quite standard in regenerative detector sets; it is controlled by varying the coupling of the tickler coil with the grid coil, or by regulating the flow of R.F. current with a variable condenser or resistor—all of which have a tendency to change the frequency of oscillation. It used to present a great many problems to the setbuilding fan, to obtain—and then control—circuit oscillation.

In Fig. 1B, we have *reversed feedback*; the plate circuit, which carries much more current, is tuned. A tickler coil is also used, but coupled into the grid circuit. This is not a suitable receiver circuit; since it would be far less sensitive to incoming signals; but in an oscillator we are concerned only with outgoing signals. This circuit is an elementary one, but little used in service testers.

Tuned-Grid, Tuned-Plate. In radio set work, it was fairly obvious that, if both grid and plate circuits could be tuned alike, selectivity and sensitivity would be highly increased (Fig. 1C). They would respond to each other much more efficiently. But, unfortunately for reception, circuit oscillation could not be prevented without throwing away the efficiency thus obtained. A great deal of ingenuity was spent "neutralizing" R.F. amplifiers to stop circuit oscillation. For an oscillator, though, the combination was very effective; and was used in transmitters. In service oscillators, however, the requirement of varying the tuning of 2 circuits, instead of 1, over a wide range would complicate the operation; and is therefore undesirable.

Meissner Oscillator. Another type of transmitting circuit, similarly useful in transmission, but avoided in service instruments, because of complications, is shown here, Fig. 1D, only for theoretical interest. The Meissner circuit tunes neither grid nor plate circuit to resonance; but does tune a separate or "tank" circuit L1-C1, which is coupled inductively to both grid and plate coils (L2A-L2B), and locks them together while oscillating at its own "natural" frequency, determined by its capacity and inductance (both of which are changed, to a certain extent, by the fact of the coupling).

The Hartley Circuits. We now come to the circuit best adapted, by adaptation from transmitter practice, to the Service Man's "signal generator." In the Hartley *series-feed* circuit (Fig. 1E, as in the Meissner, plate and grid coils are connected; but the tuning is across both. That is to say, the return circuit from plate to cathode passes through the part of the tuned coil shown as L1B; but, since the whole coil (L1A-L1B) is across the control-grid and cathode, all the fluctuations of the plate current are expressed in fluctuations of the control-grid voltage. These, in turn, cause greater fluctuations of the plate current; and soon the circuit is oscillating at the frequency determined by the tuning of the (control) grid coil.

This circuit is called *series feed*, because the plate circuit is in series with the coil L1B and direct current is therefore flowing in part of the tuned circuit. We can, however, eliminate the D.C. from this coil, though permitting the R.F. variations to surge through it, by using the Hartley *parallel-feed* circuit (Fig. 1F). Here, it will be seen, the R.F. circuit through L1B and C2 is parallel with that through the plate battery ("+" = "-"); though the latter passes the whole of the D.C. The less direct current flowing, the more exact the frequency control.

In the Hartley circuits, the position of the tap on the coil is of great importance in properly proportioning grid and plate inductances and, therefore, the proportion of the R.F. voltages. The Hartley circuit is, probably, the most widely-used oscillator in service testing work.

Colpitts Oscillator. In the circuit of Fig. 1G—the Colpitts—instead of the inductance, the capacity is split into 2 variable series condensers C1A-C1B; the midpoint between which is connected to the cathode. The grid condenser, Cg, prevents the D.C. of the plate circuit from passing through the tuned coil, but it passes freely the R.F. variations. (For this reason, the grid-leak R, is connected, not to the tuning coil, but

There is no other Permanent Magnet Speaker like this NOKOIL



No. 1984

Cadmium plating makes all parts thoroughly rust-proof which is essential to perfect permanent performance.

A super-sensitive high power Public Address NOKOIL Reproducer at a price that is within the reach of all sound engineers.

List Price **\$19.84** Dust proof Rust proof Weather proof

Write for catalog showing the World's most complete line of NOKOIL Reproducers and the name of our nearest distributor. Wright-DeCoster distributors are always anxious to cooperate.

WRIGHT-DECOSTER, Inc.

2251 University Ave., St. Paul, Minnesota
Export Dept.—M. Simons & Son Co., New York.
Cable Address: "Simontrics."
Canadian Office, Associated Sales Co., Guelph, Ont.

CHEKATUBE \$19.95

Without case for test bench. f. o. b. factory



Size 10X11X6
Weight 10 lbs.
Tests all Tubes Without Adaptors
10 Days free trial

With portable case \$21.95

Finest tube tester on the market. New power level ballast rectifier circuit—not a common emission tester. Simple. All shorts and open circuits on neon lamp while hot filament rotary switch permits testing 6P7-6Z5-5Z4-5X4 and all others. Completely wired unit on panel for mounting in carrying case or in test bench. ORDER DIRECT 10 days free trial—MONEY BACK GUARANTEE. Write for free literature.

Established 1922 J-M-P Manufacturing Co., Inc. 3044 N. 34th St., Milwaukee, Wis.

RADIO ENGINEERING

broadcasting, aviation and police radio, servicing, marine radio telegraphy and telephony, Morse telegraphy and railway accounting taught thoroughly. Engineering course of nine months' duration equivalent to three years of college radio work. All expenses low. Catalog free. School established 1874. Dodge's Institute, Hudson St., Valparaiso, Ind.

INVENTORS

TIME COUNTS—don't risk delay in patenting your ideas. Write for new FREE book, "Patent Guide for the Inventor" and "Record of Invention" form. No charge for preliminary information.
CLARENCE A. O'BRIEN & HYMAN BERMAN
Registered Patent Attorneys
533-K Adams Building, Washington, D.C.

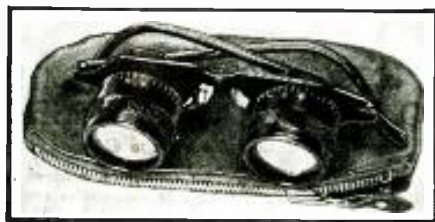

New Achromatic Sports Binocles

THIS is the first time an *Achromatic SPORTS BINOCLE* has ever been offered at this low price—it is just what sport fans have been awaiting. It is also ideal for football, prize-fights, races, hunting, fishing, boating and hiking.

Great for All Year 'Round Use!

Selling in better stores for \$12.50; take advantage of this genuine bargain. 2½ by 30—30mm, objective lenses. Wide field of vision free from distortion and color fringes. Individually focusing and marked eye-pieces. Lightweight frame of special construction. Comfortable fitting temples and nose bridge. Sent postpaid for \$4.95 complete, including Suede Leather Zippered Bag.

GREN PARK COMPANY

99 HUDSON STREET NEW YORK, N. Y.

MAIL COUPON TODAY!

GREN PARK COMPANY RC-137
99 HUDSON STREET, NEW YORK, N. Y.
Gentleman: Enclosed you will find my remittance of \$4.95 for which send me at once, POSTAGE PREPAID, one Achromatic SPORTS BINOCLES, including Suede Leather Zippered Case.

Name

Address

City State.....

(Send your remittance in check or money order. If your letter contains cash or unused U. S. postage stamps, register it.)

Please Say That You Saw It in RADIO-CRAFT

EDUCATIONAL RADIO BOOKS



RADIO FANS! . . . Help yourselves to a radio education for the price of 40c. (10c per book). These books will give you a sound foundation towards the study of radio. You'll be amazed at the wealth of information contained in them;—and you'll wonder how we can sell them at the low price of 10c each. Each book contains 32 pages written in simple, understandable language and profusely illustrated with circuit diagrams and illustrations. They are especially written for beginners but are useful review and reference books for the old timers as well.

ALL ABOUT AERIALS

In simple, understandable language this book explains the theory underlying the various types of aerials; the inverted "L," the Doublet, the Double Doublet, etc. It explains how noise free reception can be obtained, how low-impedance transmission lines work; why transposed lead-ins are used. It gives in detail the construction of aerials suitable for long-wave broadcast receivers, for short-wave receivers, and for all-wave receivers. The book is written in simple style. Various types of aerials for the amateur transmitting station are explained, so you can understand them.

ALTERNATING CURRENT FOR BEGINNERS

This book contains everything to give the beginner a foothold in electricity and Radio. Electric circuits are explained. Ohm's Law, one of the fundamental laws of radio, is explained; the generation of alternating current; sine waves; the units—volts, amperes, and watts are explained. Condensers, transformers, A.C. instruments, motors and generators—all these are thoroughly discussed. Housewiring systems, electrical appliances and electric lamps.

Here are some of the practical experiments which you can perform at home. Simple tests for differentiating between alternating and direct current; how to light a lamp by induction; making a simple electric horn; demagnetizing a watch; testing motor armatures; charging storage batteries from A.C. outlet; testing condensers with A.C.; making A.C. electro magnets; frying eggs on a cake of ice; making simple A.C. motors and many others.

HOW TO MAKE THE MOST POPULAR ALL-WAVE 1- and 2-TUBE RECEIVERS

There has been a continuous demand right along for a low-priced book for the radio experimenter, radio fan, radio Service Man, etc., who wishes to build 1- and 2-tube all-wave sets powerful enough to operate a loudspeaker.

This book contains a number of excellent sets, some of which have appeared in past issues of RADIO-CRAFT. These sets are not toys but have been carefully engineered. They are not experiments. To mention only a few of the sets the following will give you an idea.

- The Meadayne 1-Tube Pentode Loudspeaker Set, by Hugo Gernsback.
- Electrifying The Meadayne.
- How to Make a 1-Tube Loudspeaker Set, by W. P. Chesney.
- How to Make a Simple 1-Tube All-Wave Electric Set, by F. W. Harris.
- How to Build a Four-In-Two All-Wave Electric Set, by J. T. Bernsley, and others.

HOW TO MAKE FOUR DOERLE SHORT WAVE SETS

Literally thousands of radio fans have built the famous DOERLE Short Wave Radio Receivers. So insistent has been the demand for these receivers, as well as construction details, that this book has been specially published.

Contains EVERYTHING that has ever been printed on these famous receivers. These are the famous sets that appeared in the following issues of SHORT WAVE (CRAFT: "A 2-Tube Receiver that Reaches the 12,500 Mile Mark," by Walter C. Doerle (Dec., 1931-Jan., 1932). "A 3-Tube 'Signal Gripper,'" by Walter C. Doerle (November 1932). "Doerle '2-Tube' Adapted to A. C. Operation" (July 1933). "The Doerle 3-Tube 'Signal-Gripper' Electrified," (August 1933) and "The Doerle Goes 'Band-Spread'" (May, 1934).

Due to a special arrangement with SHORT WAVE CRAFT, we present a complete 32-page book with stiff covers, printed on an extra heavy grade of paper with numerous illustrations. Nothing has been left out. Not only are all the DOERLE sets in this book, but an excellent power pack if you wish to electrify any of the DOERLE sets, is also described.

Each book contains 32 pages, profusely illustrated with clear, self-explanatory diagrams. It contains over 15,000 words of clear legible type. It is an education in itself and lays the ground-work for a complete study of radio and electricity.

If you do not think that this book is worth the money asked for it, return it within 24 hours and your money will be instantly refunded.

Radio Publications
99A Hudson St., New York, N. Y.

direct to cathode.) The choke R.F.C., with low resistance, but high R.F. inductance, builds up across condenser C1B an R.F. voltage which is communicated to the coil L1 which they tune.

Dynatron Oscillator. With the introduction of the 4-element (screen-grid) tube, another method of producing oscillations in a tube circuit was found. This depends on the peculiar "characteristic" curve of such a tube, when there is a higher voltage (positive) on one of the grids than on the plate. (Fig. 111.) There is an oscillation of electrons (secondary electrons, "bounced back" from the plate) between plate and higher-voltage grid; and, when a tuned circuit (L1-C1) is applied between the plate and the (screen-) grid, it forms a "tank" circuit; keeping the tube circuit in oscillation with the power it takes up from the tube.

SUMMARY

These are the principal methods of feeding back a tube's plate-current variations as grid-voltage variations; so that the tube keeps on producing an alternating voltage, at a high frequency determined by the tuning of its circuits—what we know as oscillation.

However, the oscillator, to be of much use to the radio Service Man, must have a modulated output. This subject of modulation will be discussed in a forthcoming issue of *Radio-Craft*. (The original references from which this material was prepared have been taken from the author's book, "Modern Radio Servicing.")

This article has been prepared from data supplied by courtesy of Radio & Technical Publishing Co.

NEW DEVELOPMENTS IN CATHODE-RAY EQUIPMENT

(Continued from page 413)

production-run tubes. The intensity control is a potentiometer across which is taken the control-grid potential for the cathode-ray tube. A focus control regulates the applied potential to the No. 1 anode for varying the distance at which the electronic beam focuses. Protective couplings are utilized to insure the operator against any possibility of coming in contact with the high-potentials that are developed in the cathode-ray tube power supply.

THE "PHASE SPLITTER"

In the study of Lissajou's figures the patterns as viewed on the screen of the cathode-ray tube are not easily interpreted, especially when the front and rear portions are in the same plane, so in order to aid in the interpretation of the patterns there has been incorporated in the unit a phase-splitting device which affords a means for simplifying the patterns by separating the two that are in the same plane.

This unique method of separation is accomplished by utilizing a fixed resistor and condenser; across the latter there is connected a variable resistor, or phase control, the purpose of which is to vary the phase relation which exists between the real or in-phase component and the reactive or out-of-phase component. At the position of maximum resistance of the variable resistor, the phase angle between the 2 components is approximately 90 deg.; a decrease in the ohms value of the resistor results in a decrease in the existing phase relation. By connecting one set of deflecting plates across the reactive branch of the circuit and the other set across the real, the pattern as seen on the screen of the tube will be displaced on a circle or an ellipse dependent upon the setting of the phasing control. Thus by the proper use of this device one may easily study Lissajou's figures without the confusion of two images in the same plane which would ordinarily exist.

The horizontal and vertical amplifiers are both of the same design, having a practically flat-line frequency response curve from 20 to 90,000 cycles, and a gain of approximately 40. The switching arrangement of both amplifiers allows the signal under study to be routed through the amplifiers for amplification purposes or connected directly to the deflection plates.

There have also been incorporated the necessary synchronizing controls for synchronization of the signal under study with the linear time base. Provisions have been made for internal synchronization as well as external; internal synchronization being accomplished by introduc-

Send for our FREE circular listing 48 new 10c Publications

RADIO PUBLICATIONS RC-137
99A Hudson Street
New York, N. Y.

Please send immediately books checked:

How to Build Doerle Short-Wave Sets, No. 1 10c

How to Make the Most Popular All-Wave 1- and 2-Tube Receivers, No. 2 10c

All About Aerials, No. 4 10c

Alternating Current for Beginners, No. 3 10c

I am enclosing the price of each book is 10c. (U. S. Coin or U. S. Stamps acceptable.) Books are sent postpaid.

Send me also your FREE circular listing 48 new 10c publications

Name

Address

City State

14 SCIENTIFIC BOOKS COMBINED IN ONE VOLUME!

Dozens of Chapters Covering Many Branches of Science
Hundreds of Scientific Illustrations and Photos

Here are all the modern wonders of physics, chemistry, biology, astronomy, engineering, electricity and other scientific subjects included in ONE VOLUME . . . and just crowded with pictures. SCIENTIFIC WONDERS OF THE WORLD describes the world in which we live and the universe all around us. It explains how man has tamed the powers of nature. We see the oddities of biology, the wonders of plants and animals. The marvels of geography and geology are explained. We learn about the radio, the telephone and the talkies and many other interesting scientific projects.

Even the few topics just described indicates clearly the dazzling profusion of text and illustration which you will find in this book. Here are a few chapters from the contents: The Enigma of Evolution; Dust Storm Dangers; Uses of Bromine; Reflections of Light; Land and Sea Breezes; The Wonderful Telegraph; Earth's Nearest Neighbor; Wonders of Television; Mystery of Light; Meteors and Comets; Wonders of the Radio; All About Power; and many other interesting articles.

Sent POSTPAID anywhere in U.S.A. **\$1.95**
Check or money order accepted.

GRENPAK COMPANY, 101R Hudson Street, New York, N. Y.

Please Say That You Saw It in RADIO-CRAFT

ADVERTISERS' INDEX

A	
Aalloy Transformer Co., Inc.	437
AIR [®] Radio Laboratories	439
Aerovox Corporation	439
Allied Radio Corporation	424
American Technical Society	432
Amplifier Co. of America	410
Ampl-tone Products Co.	437
Arrow Sales Corporation	435
C	
Central Radio Laboratories	430
Classified Section	441
Clough-Bronck Company	437
Continental Carbon, Inc.	436
Cornell-Dubilier Corp.	411
Coyne Electrical School	425
D	
Dodge's Institute	443
Allyn W. Dumont Labs, Inc.	430
E	
Ellen Radio Laboratories	427
Electrad, Inc.	437
Electrical Institute	428
Electro-Dyne Mfg. Co.	445
G	
General Cement Mfg. Co.	439
General Electric Company	Back Cover
Goldstone Radio Co.	438
Grenpark Company	413, 411
H	
Hammarlund Mfg. Company	437
Hygrade-Sylvania Corp.	422
I	
Illinois Condenser Company	435
Industrial Amplifier Systems Co.	431
International Corresp. Schools	442
J	
J M P Manufacturing Co.	441
Jobs & Careers	443
K	
Kenyon Transformer Co., Inc.	431
L	
Lincoln Engineering School	445
Lynch Manufacturing Co., Inc.	435
M	
McGraw-Hill Book Company	431
Midwest Radio Corporation	419
Million Radio & Tel. Labs.	440
N	
National Radio Institute	387
National Schools	435
National Union Radio Corp.	429
New York YMCA Schools	429
Norwest Radio Labs.	432
O	
Clarence A. O'Brien & Hyman Berman	443
Oxford-Tartak Radio Co.	435
P	
Paragon Radio Products	432
Paramount Trading Co.	440
Precision Apparatus Corp.	438
R	
RCA Institutes, Inc.	435
RCA Manufacturing Co., Inc.	438
Radio & Technical Publ. Co.	424, 425
Radio & Television Institute	438
Radio Circular Company	442
Radio City Products Company	435
Radio Publications	444
Radio Service Institute	433
Radio Training Assoc. of America	423
Radolek Company	445
Raytheon Production Corp.	430
Readrite Meter Works	Inside Front Cover
Remington Rand, Inc.	441
S	
S. O. S. Corporation	442
Shallcross Mfg. Co.	436
Solar Mfg. Company	445
South Bend Lathe Works	429
Sprayberry Academy of Radio	437
Superior Instrument Co.	431
Supreme Instruments Corp.	387A, 387B
T	
Telex Company	442
The Plan Shop	439
Triad Mfg. Company	425
Triplet Elec. Instrument Co.	426
Triumph Mfg. Company	421
Try-Mo Radio Co., Inc.	439
U	
United Radio Company	437
United Sound Engineering Co.	441
Universal Microphone Co. Ltd.	434
W	
Wellworth Trading Company	442
Weston Elect. Instrument Corp.	Inside Back Cover
Wholesale Radio Service Co.	439
Williams Photo. Inc.	435
Wright-DeCoster, Inc.	443
Z	
Zephyr Radio Company	429

(While every precaution is taken to insure accuracy, we cannot guarantee against the possibility of an occasional change or omission in the preparation of this index.)

ing a potential drop (secured across a resistor in the vertical amplifier plate circuit) into the control-grid circuit of the type 885 gaseous discharge tube, allowing locking in step of the linear time base with fundamentals or sub-multiples of the signal under study. The type 885 gaseous discharge tube is used in a well-designed circuit, the constants of which are so chosen that exceptionally good linearity is obtained.

Therefore, summing up the foregoing, we have a completely self-contained cathode-ray apparatus capable of wider range of test work than any other instrument of its type so far developed.

CIRCUIT ADDENDA

(Continued from page 413)

and vertical deflecting plates, V4 serving as the vertical amplifier and V5 as the horizontal amplifier. The type 885 tube, in conjunction with the 6 condensers, is utilized for creating the linear time base. The type 879 is used as a half-wave high-voltage rectifier for supplying the necessary potentials to the type 906 cathode-ray tube. The type 80 tube is also used for supplying rectified D.C. potential for use in conjunction with the horizontal and vertical amplifier and also saw-tooth oscillator or linear time base generator.

The inductances L1 to L4 inclusive are associated with the R.F. signal generator for creating at the R.F. output pin-jacks an R.F. carrier signal which may be varied from 125 kc. to 60 mc.; from 125 kc. to 15 mc. at fundamentals and from 15 mc. to 60 mc. by harmonics.

The ratio of the transformer which is utilized in connection with the variable audio frequency output is 2 to 1 and is designed for operating directly into a 500-ohm line.

The services of potentiometers R1 to R10 are as follows: R1, for varying the R.F. output of the signal generator when used in connection with the ladder-type attenuator circuits; R2, horizontal-gain control; R3, vertical-gain control; R4, phasing control; R5, synchronizing control for external, internal or local power supply synchronization; R6, vernier frequency control of the linear time base generator; R7, intensity control; R8, focus control; R9 and R10, spot adjustment controls. None of these potentiometers are ganged.

The oscillating frequencies of the variable oscillatory circuits are as follows: (1) a fixed frequency oscillator which is frequency-modulated at a mean frequency of 600 kc., plus or minus 12 kc., the total band width being 24 kc.; (2) the modulator stage or A.F. oscillator which is used for amplitude-modulation of the R.F. carrier being peaked at 400 cycles; (3) the main R.F. oscillatory circuit which may be continuously-variable from 125 kc. to 15 mc. at fundamentals and for further extension of this particular function we use harmonics which extend to 60 mc. which is a 4th-harmonic of 15 mc. The variable A.F. oscillator (as we mentioned before) is continuously-variable from 50 cycles to 10 kc. The linear time base is continuously-variable from 7 cycles to 20 kc.

The function of switches Sw.1 to Sw.9, inclusive, are: Sw.1, output function selector for making the proper connections to the type 6F7 which is used in conjunction with the 6A7 for creating at the output pin-jacks either a frequency-modulated signal which is frequency-modulated over a constant band width of 24 kc. or a variable A.F. output which may be varied from 50 cycles to 10 kc. and an amplitude-modulated R.F. output which is modulated with a 400 cycle note at 30 per cent. Switch Sw.2 is the range selector for the R.F. signal generator section. Switch Sw.3 is a unit not located on the original circuit diagram. Switch Sw.4 is the multiplier switch in the attenuator circuit. Switch Sw.5 is the "On-Off" switch for the Signal Generator section. Switch Sw.6 is the switch for the horizontal amplifier. Switch Sw.7 should be ganged with Sw.6. Switch Sw.8 is the range selector switch for the time-base generator. Switch Sw.9 is the synchronizing switch which is utilized in connection with the 885 for synchronizing the input voltage with the time-base internally, externally, or with the local power supply. Switch Sw.10 is used as an "On-Off" switch for the oscilloscope functions of the diaphragm. Switch Sw.11 is the safety switch mounted in the case so that the cover cannot be removed with the supply "On."

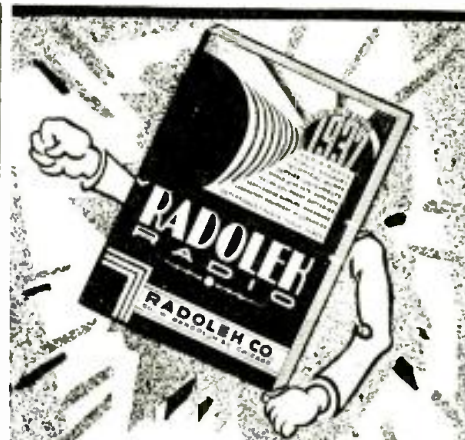

"The Most Complete Radio Buying Guide"

10,000 Money-Savers!

Completely revised—right up to the minute—bringing you everything in radio—at the right prices. Over 10,000 Repair Parts—a complete selection of Receivers, Amplifiers, Tubes, Tools, Books, Instruments—always in stock—ready for speedy shipment to you. You need this big Radio Parts Catalog. It's free! Send for it.

Radolek endeavors to restrict distribution of the Profit Guide to those actively and commercially engaged in the Radio Business. Please enclose your Business Card or Letterhead.

RADOLEK

601 W. Randolph St., Dept. C-1, Chicago
Send the Radolek Profit Guide Free

Name

Address

Service man? Dealer? Experimenter?



Precision CAPACITOR ANALYZER

Capacity, power factor, leakage, resistance, directly on the panel. Highly sensitive No. 6E5 cathode ray tube used for balancing. Dial color-coded to match settings. A refined and extended Wien bridge, instantly usable in shop and field. Two models, low priced.

QUICK as a WINK!
write for full details

SOLAR MFG. CORP.

599-601 BROADWAY NEW YORK CITY

Correspondence Courses in RADIO and ELECTRICAL ENGINEERING

ELECTRICAL ENGINEERING covers complete electrical field. Most modern course. So simplified anyone can grasp it quickly. **LOW COST!** Only \$25. Deferred payment plan. **RADIO ENGINEERING** Ultra-modern course in radio, public address photo-electric work. Trains you to be super-service man, real vacuum tube technician. Diploma given. Tuition only \$25. Deferred payment plan.

FREE Write today for free copies of school catalogs, student magazines, etc. Get started at once. **SEND NOW!** LINCOLN ENGINEERING SCHOOL, 931-8 So. 37th St., Lincoln, Neb.

DYNAMIKE!

A real velocity, high quality microphone for speech or music. Equals instruments selling for three times the price. Response substantially flat from 40 to 10,000 C. P. S. Cavity resonance eliminated through special design. High impedance. Output 60 D. B. Equipped with six feet of shielded cable. Send \$3.95 (plus postage) today or request free Circular. **ELECTRO-DYNE MFG. CO.,** Boston Harbor, Mich.

Complete details about the 1936 **OFFICIAL RADIO SERVICE MANUAL** appear on Page 388 of this issue. Turn to this announcement NOW!

Please Say That You Saw It in RADIO-CRAFT

GERNSBACK RADIO MANUALS AND SERVICE HANDBOOK ARE AVAILABLE FROM JOBBERS AND MAIL ORDER HOUSES

Your nearest radio jobber and mail order house carries a complete stock of Gernsback Official Radio Service Manuals and Service Handbooks. For quick, efficient service visit or write them today. There is no delay. Your Manual or Handbook will be in your hands in a day or two. Our vast distribution network permits us to offer you the rapid, intelligent service you have a right to expect from your publisher.

Here's the New Book for Radio Men!

Official Radio Service Handbook by J. T. Bernsley



HERE'S the new book on radio servicing that contains everything Service Men must know. The book, OFFICIAL RADIO SERVICE HANDBOOK, is edited by J. T. Bernsley, foremost radio service authority. This 1936 service guide is the only book of its kind—its editorial material is so well prepared that the technical information can be understood by even beginners in radio servicing. Every page contains new material, new illustrations—no reprinted literature. The OFFICIAL RADIO SERVICE HANDBOOK covers thoroughly over 500 radio topics. It tells you how to analyze the latest commercial receiver circuits; how to really make money servicing midget sets; and, how aligning supers can be made easy. It stresses the many uses of different types of test equipment; it gives you short cuts in trouble-shooting and repairing; and, contains over 250 pages of operating notes on 1,000 manufactured receivers. So up-to-date is the OFFICIAL RADIO SERVICE HANDBOOK that it explains thoroughly the features and innovations in the most modern of receivers.

Partial Contents of This Great Book!

- PART 1—CIRCUIT THEORY AND ANALYSIS**
R.F. Fundamentals; Superheterodyne Receiver Theory; A.V.C. and Tuning Indicator Circuits; A.F. Fundamentals; Power Supply Theory and Circuits; Speakers, Reproducers and Pick-Ups; Commercial Receiver Circuits of All Types, How to Analyze.
- PART 2—MODERN SERVICING AND TEST EQUIPMENT**
Fundamentals of Metering and Test Equipment; Standard Servicing Instruments; The Cathode Ray Oscilloscope and Associate Instruments; How to Build Essential Servicing Test Instruments.
- PART 3—PRACTICAL SHORT-CUTS IN TROUBLE SHOOTING AND REPAIRING**
Localizing Trouble by Inspection Methods; Short-Cuts with Test Instruments; How to Quickly and Properly Perform All Types of Repairs; Unusual Servicing Experiences; Tube Troubles and Characteristics.
- PART 4—SPECIALIZED RECEIVER AND INSTALLATION DATA**
All-Wave and High Fidelity Receiver Servicing and Installation Data; Auto Radio Receiver and Installation; Specialized Servicing and Installation (Remote Tuning Controls, Home Recording, Automatic Record Changers, Apartment House Antennae, etc., etc.); Eliminating Noise Interference.
- PART 5—MODERNIZATION AND CONVERSION DATA**
Modernizing and Improving Methods for All Types of Receivers; Converting A.C. Receivers for D.C. Operation and Vice Versa.
- PART 6—SOCIAL AND ECONOMIC PROBLEMS OF THE SERVICE MAN**
Improving Knowledge and Technique; Social Problems—How to Organize, Listing of Servicemen's Organizations; The Future of the Servicing Profession.
- PART 7—OPERATING NOTES AND PRACTICAL DATA LISTINGS**
Operating Notes on Over 1,000 Receivers; I.F. Peaks of Approximately 3,000 Receivers; Voltage Dividers for 300 Receivers, Speaker Field Listing; Radio Mathematics and Measurements.

OVER 250 PAGES OF OPERATING NOTES

Whether it is a fading job, lack of sensitivity, noise within the receiver, aligning a chassis, poor A.V.C. action, a "cockeyed" Magic Eye tuning indicator or any other trouble that is usually the "bugaboo" of most Service Men, you will find the symptoms and remedy clearly described in OFFICIAL RADIO SERVICE HANDBOOK. The exact procedure for repairing, as well as the characteristic trouble in almost all models of manufactured sets, will be found in this section on OPERATING NOTES—over 250 pages of this data, the most important information to any radio man in the servicing field. The author takes nothing for granted. The procedure for aligning supers, whether one, two, three or more bands, is clearly and practically explained. You can quickly grasp the ideas and put them into successful practice. The material in this section has been arranged, as well as classified, so there is no difficulty in immediately locating the necessary information.

OVER 1,000 PAGES
OVER 1,000 ILLUSTRATIONS
Beautiful Linen, Gold-Stamped Cover 6 x 9 Inches

THE
1936 MANUAL
IS READY
See Page 388

If your jobber or mail order house cannot supply you, order any of the OFFICIAL RADIO SERVICE MANUALS or the OFFICIAL RADIO SERVICE HANDBOOK directly from the publishers. Send your remittance in form of check or money order—if you send cash or unused U. S. Postage Stamp, be sure to register your letter. ALL ORDERS ARE FILLED PROMPTLY. BOOKS ARE SENT TO YOU POSTAGE PREPAID. Address Dept. RC-137.

RADCRAFT PUBLICATIONS, INC.
99 HUDSON STREET
NEW YORK, N. Y.

THE
1936 MANUAL
IS READY
See Page 388

WHICH OF THESE OFFICIAL RADIO SERVICE MANUALS DO YOU NEED TO COMPLETE YOUR FILES?

There's perhaps one or more of these great service manuals which you might need to complete the set. Collectively they represent the largest collection of service data ever compiled. Evidence of their importance to Radio men is shown by the fact that over 80,000 OFFICIAL RADIO SERVICE MANUALS have been sold during the past few years.



- 1935 OFFICIAL RADIO SERVICE MANUAL**
Over 1,000 Pages, 9 x 12 Inches Over 3,000 Illustrations
Flexible, Looseleaf, Leatherette Cover
List Price \$7.00
- 1934 OFFICIAL RADIO SERVICE MANUAL**
Over 400 Pages, 9 x 12 Inches Over 2,000 Illustrations
Flexible, Looseleaf, Leatherette Cover
List Price \$3.50
- 1933 OFFICIAL RADIO SERVICE MANUAL**
Over 700 Pages, 9 x 12 Inches Over 2,000 Illustrations
Flexible, Looseleaf, Leatherette Cover
List Price \$5.00
- 1932 OFFICIAL RADIO SERVICE MANUAL**
Over 1,000 Pages, 9 x 12 Inches Over 2,000 Illustrations
Flexible, Looseleaf, Leatherette Cover
List Price \$5.00
- 1931 OFFICIAL RADIO SERVICE MANUAL**
650 Pages (Including Supplements) 9 x 12 Inches
Over 1,500 Illustrations
Flexible, Looseleaf, Leatherette Cover
List Price \$4.50
(Including Supplements)



For Car-Radio Servicing—Get These AUTO-RADIO SERVICE MANUALS

- 1935 Official Auto-Radio Service Manual**
Over 240 Pages 9 x 12 Inches
Over 500 Illustrations
Flexible, Looseleaf, Leatherette Cover
LIST PRICE \$2.50
- 1933 Official Auto-Radio Service Manual**
Over 240 Pages 9 x 12 Inches
Over 500 Illustrations
Flexible, Looseleaf, Leatherette Cover
LIST PRICE \$2.50

OVERSEAS READERS
These books can be obtained from the following houses:

GREAT BRITAIN
Gerringe's, 9a, Green Street, Leicester Square, London, England

FRANCE
Editions Radio, 42 Rue Jacob, Paris

AUSTRALIA
McGill's 183-195, 218 Elizabeth St., Melbourne, C. I.

NEW ZEALAND
James Johnston, Ltd. 393 Princes St., Dunedin, C. E.

Please Say That You Saw It in RADIO-CRAFT

RECTIFIED RF SIGNAL CURRENT
 HIGH-MU TRIODE PLATE VOLTAGE
 AFC (AUTOMATIC FREQUENCY CONTROL)
 DIODE BALANCING CIRCUITS
 OSCILLATOR AND POWER
 TUBE GRID CURRENTS
 POWER DETECTOR BIAS
 AVC DIODE CURRENTS
 PHOTO-CELL CURRENTS
 AND PLATE VOLTAGES

*measure
 them* **ALL**
 WITH THE
**Super-Sensitive
 WESTON**
Model 772
 (20,000 OHMS PER VOLT)

\$46⁵⁰_{NET}

**TO DEALERS
 IN U. S. A.**

and remember . . .

you can buy this fantous 20,000 ohms per volt analyzer, and other WESTON radio instruments, through the convenient WESTON INVESTMENT PLAN.



No instrument yet offered the serviceman has met with such overwhelming response as Model 772. The reasons are obvious. With its sensitivity of 20,000 ohms per volt, Model 772 is not only ideal for all usual testing routine . . . but it also enables you to get into and thoroughly check circuits which cannot be tested with former servicing instruments. And being built to high WESTON

standards, servicemen know that Model 772 will serve dependably for years. Before you consider the purchase of test equipment be sure to get all the facts on Model 772 and other WESTON instruments for radio servicing. Ask your jobber for full particulars or return the coupon today . . . Weston Electrical Instrument Corporation, 599 Frelinghuysen Avenue, Newark, New Jersey.

WESTON
Radio Instruments

Weston Electrical Instrument Corporation
 599 Frelinghuysen Avenue, Newark, N. J.
 Send full data on Model 772 and other WESTON Instruments.

NAME _____
 ADDRESS _____
 CITY _____ STATE _____

AT LAST, A RADIO YOU CAN'T TUNE WRONG



*Focused
Tone*

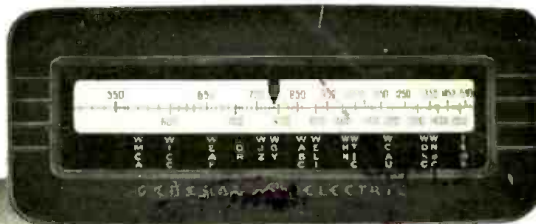

Perfect Tuning . . Perfect Tone . . Automatically!

SET THE dial of the new G-E Radio off-tune — as nine out of ten people do without knowing it — and you'll get the surprise of your life. Instantly, the new G-E automatically shifts itself into hair-line tuning. And, simultaneously the amazing new G-E Colorama Dial changes from red to green to tell you "here's your station perfectly tuned — every note true and clear."

Everything about the new G-E is thrilling and amazing. It's a Personalized Radio — with a Custom-tailored Dial. Your local station letters flash on when you tune in. No more hunting up kilocycle numbers — because stations are marked by letters as well as kilocycles. The new G-E gives you silent tuning, too — you can switch from one program to another without a single squeal, squawk, or screech. But the biggest thrill of all is the life-like, flawless tone of the new G-E.

See and hear — for yourself — radio's newest marvel. Stop in soon at the G-E Radio Dealer's nearest you. Let your ears decide whether any other radio, at any price, can equal the tone and performance of the greatest radio G.E. has ever built.



*Off-Focus
Tone*



*G-E Focused
Tone*



*Off-Focus
Tone*

GLADYS SWARTHOUT — glamorous star of the Metropolitan Opera — Radio — Movies.

— harsh, blurred, discordant tone. Nine out of ten people unknowingly tune in their radios off focus.

The new G-E Radio automatically shifts itself into hair-line tuning every time. And, at the same instant, the Colorama Dial changes from red to green, to tell you your program is in Perfect Focused Tone.

— harsh, blurred, discordant tone. Nine out of ten people unknowingly tune in their radios off focus.

WHAT IS FOCUSED TONE?

Focused Tone combines all the revolutionary new features described above, plus these new G-E Radio inventions and developments — G-E Metal Tubes; G-E Sentry Box; G-E Stabilized Dynamic Speakers; G-E Sliding-rule Tuning Scale; G-E "V-doublet" All-wave Antenna. Focused Tone is G.E.'s greatest radio achievement. Only the new G-E gives it to you — AUTOMATICALLY — VISIBLY — INSTANTLY.

AUTOMATICALLY . . VISIBLY . . INSTANTLY

You'll always be glad you bought a G-E

GENERAL  ELECTRIC
Radio

For Metal Tube Renewals, Specify G-E



The new G-E brings you every radio service on the air - Foreign Broadcasts over ALL short-wave bands; Domestic Short-wave Stations; Domestic Programs — heard with new tone perfection; Police Calls, and Amateur Stations — day and night.

The new General Electric comes in 31 handsome models — priced from \$22.50 to \$750.00 (Eastern list).

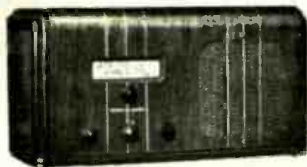

RESEARCH KEEPS GENERAL ELECTRIC YEARS AHEAD